

TTP-2410M/346M/644M
TTP-246M Plus/344M Plus

**THERMAL TRANSFER / DIRECT THERMAL
BAR CODE PRINTER**

**USER'S
MANUAL**

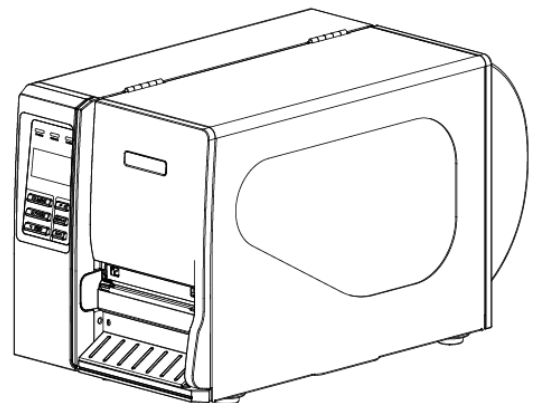

Contents

| | |
|---|-----------|
| 1. Introduction | 1 |
| 1.1 Product Introduction | 1 |
| 1.2 Compliances | 1 |
| 2. Operations Overview | 4 |
| 2.1 Unpacking and Inspection | 4 |
| 2.2 Printer Overview | 5 |
| 2.2.1 Front View | 5 |
| 2.2.2 Interior view | 6 |
| 2.2.3 Rear View | 7 |
| 2.3 Operator Controls | 9 |
| 2.3.1 Front Panel Display | 9 |
| 2.3.2 LED Indicators | 9 |
| 2.3.3 Front Panel Keys | 10 |
| 2.4 Setting Up the Printer | 10 |
| 2.5 Installation of Ribbon | 11 |
| 2.5.1 Loading the Ribbon | 11 |
| 2.5.2 Remove Used Ribbon | 14 |
| 2.6 Installation of Media | 15 |
| 2.6.1 Loading Roll Labels | 15 |
| 2.6.2 Loading Fan-fold Labels | 18 |
| 2.6.3 Loading Media in Peel-off Mode (Option) | 20 |
| 2.6.4 Remove Liner from Internal Rewind (Option) | 22 |
| 2.6.5 Loading Media in Rewind Liner with Label Mode (Option) | 23 |
| 2.6.6 Remove Labels from Internal Rewind (Option) | 25 |
| 2.7 Adjustment Knob | 26 |
| 2.7.1 Print head Pressure Adjustment Knob | 26 |
| 2.7.2 Print Head Burn Line Adjustment Knob | 26 |
| 2.8 Using the Keyboard with PS/2 Interface (Optional for TTP-246M Plus/TTP-344M Plus models) | 28 |
| 3. Menu Function | 29 |
| 3.1 Setup Menu Overview | 30 |
| 3.1.1-1 Printer Setup (TSPL2) | 31 |
| 3.1.1-2 Printer Setup (ZPL2) | 38 |
| 3.1.2 Sensor | 45 |
| 3.1.3 Serial Comm. | 53 |

| | |
|---|-----------|
| 3.1.4 Ethernet | 57 |
| 3.2 File Manager | 60 |
| 3.2.1 File List | 60 |
| 3.2.2 Avail. Memory | 60 |
| 3.2.3 Del. All Files | 61 |
| 3.3 Diagnostics | 62 |
| 3.3.1 Print Config. | 62 |
| 3.3.2 Dump Mode | 63 |
| 3.3.3 Rotate Cutter | 64 |
| 3.4 Language | 64 |
| 3.5 Service | 65 |
| 3.5.1 Initialization | 65 |
| 3.5.2 Mileage Info. | 66 |
| 4. Diagnostic Tool | 67 |
| 4.1 Start the Diagnostic Tool | 67 |
| 4.2 Printer Function (Calibrate sensor, Ethernet setup, RTC setup.....) | |
| | 68 |
| 5 Setting Ethernet by Diagnostic Utility (Optional for TTP-246M Plus/TTP-344M Plus models) | 69 |
| 5.1 Using USB interface to setup Ethernet interface | 69 |
| 5.2 Using RS-232 interface to setup Ethernet interface..... | 70 |
| 5.3 Using Ethernet interface to setup Ethernet interface | 71 |
| 6. Troubleshooting | 73 |
| 6.1 Common Problems | 73 |
| 6.2 Mechanism Fine Adjustment to Avoid Ribbon Wrinkles | 77 |
| 7. Maintenance | 79 |
| Revise History | 81 |

1. Introduction

1.1 Product Introduction

Thank you very much for purchasing TSC bar code printer.

This printer is designed with die-casting aluminum chassis and print mechanism, metal cover with large clear media view window, which ensuring to work for the extreme and heavy duty industrial environment and applications.

With back-lit graphic LCD display, printer status can be managed easier and operated more user friendly. The moveable sensor design can accept wide range of label media. All of the most frequently used bar code formats are included. Fonts and bar codes can be printed in any one of the four directions. This printer is built-in the high quality, high performance MONOTYPE IMAGING® True Type font engine and one CG Triumvirate Bold Condensed smooth font. With flexible firmware design, user can also download the True Type Font from PC into printer memory for printing labels. Besides the scalable font, it also provides a choice of five different sizes of alphanumeric bitmap font, OCR-A and OCR-B fonts. By integrating rich features, it is the most cost-effective and high performance printer in its class!

Specifications, accessories, parts and programs are subject to change without notice.

1.2 Compliances

CE Class A:

EN55022:1998+A1:2000+A2:2003:

EN55024:1998+A1:2001+A2:2003:

EN 61000-4 SERIES REGULATIONS

ETSI EN 301 489-17:V1.2.1(2002-08)

FCC:

CFR 47, Part 15/CISPR 22 3RD EDITION:1997, Class A

This device complies with Part 15 of the FCC Rules.
Operation is subject to the following two conditions.
(1) This device may not cause harmful interference, and
(2) This device must accept any interference received,
including interference that may cause undesired operation.

ANSI C63.4:2003

CANADIAN ICES-003

C-Tick:

AS/NZS CISPR22 (Class A)

UL, CUL

UL 60950 3rd

TÜV/ Safety:

EN60950: 2000

Wichtige Sicherheits-Hinweise

1. Bitte lesen Sie diese Hinweis sorgfältig durch.
2. Heben Sie diese Anleitung für den späteren Gebrauch auf.
3. Vor jedem Reinigen ist das Gerät vom Stromnetz zu trennen. Verwenden Sie keine Flüssig-oder Aerosolreiniger. Am besten eignet sich ein angefeuchtetes Tuch zur Reinigung.
4. Die Netzanschluß-Steckdose soll nahe dem Gerät angebracht und leicht zugänglich sein.
5. Das Gerät ist vor Feuchtigkeit zu schützen.
6. Bei der Aufstellung des Gerätes ist auf sicheren Stand zu achten. Ein Kippen oder Fallen könnte Beschädigungen hervorrufen.
7. Beachten Sie beim Anschluß ans Stromnetz die Anschlußwerte.
8. Dieses Gerät kann bis zu einer Außentemperatur von maximal 40°C betrieben werden.

CAUTION

- 1. HAZARDOUS MOVING PARTS IN CUTTER MODULE. KEEP FINGER AND OTHER BODY PARTS AWAY.**
- 2. THE MAIN BOARD INCLUDES REAL TIME CLOCK FEATURE HAS LITHIUM BATTERY CR2032 INSTALLED. RISK OF EXPLOSION IF BATTERY IS REPLACED BY AN INCORRECT TYPE.**
- 3. DISPOSE OF USED BATTERIES ACCORDING TO THE MANUFACTURER INSTRUCTIONS.**
- 4. DO NOT OPEN THE PRINTER RIGHT SIDE COVER WHEN THE PRINTER IS PRINTING.**

"ORSICHT"

Explosionsgefahr bei unsachgemäßen Austausch der Batterie. Ersatz nur durch denselben oder einem vom Hersteller empfohlenem nlichen Typ. Entsorgung gebrauchter Batterien nach Angaben des Herstellers.

A 급기기

(업무용 정보통신기기)

이 기기는 업무용으로 전자파 적합등록을 한 기기이오니, 판매자 또는 사용자는 이 점을 주위하시기 바라며, 만약 잘못 판매 또는 구입하였을 때에는 가정용으로 교환하시기 바랍니다.

2. Operations Overview

2.1 Unpacking and Inspection

This printer has been specially packaged to withstand damage during shipping. Please carefully inspect the packaging and printer upon receiving the bar code printer. Please retain the packaging materials in case you need to reship the printer.

Unpacking the printer, the following items are included in the carton.

- One printer unit
- One Windows labeling software/Windows driver CD disk
- One quick installation guide
- One power cord
- One USB interface cable

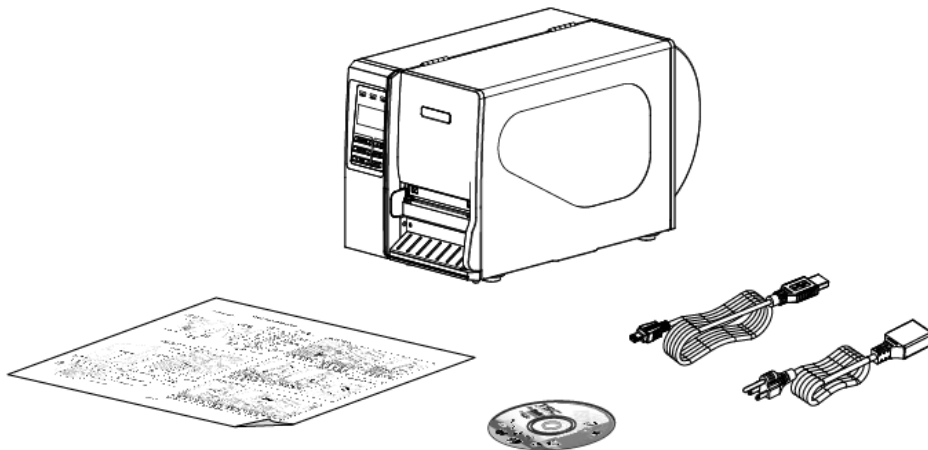

If any parts are missing, please contact the Customer Service Department of your purchased reseller or distributor.

2.2 Printer Overview

2.2.1 Front View



1. LED indicators
2. LCD display
3. Front panel buttons
4. Paper exit chute
5. Lower front cover
6. Printer right side cover

2.2.2 Interior view

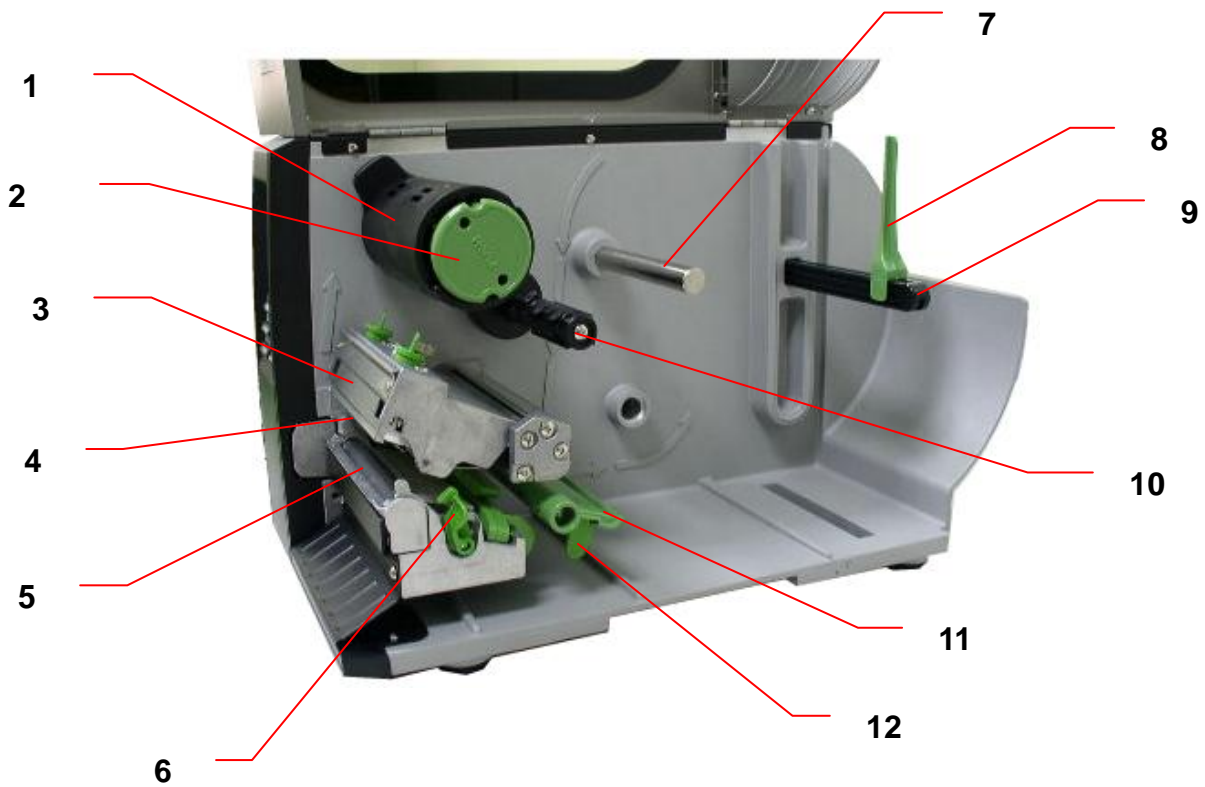

- 1. Ribbon rewind spindle
- 2. Ribbon release button
- 3. Ribbon guide plate
- 4. Print head
- 5. Platen roller
- 6. Print head release lever
- 7. Media guide bar
- 8. Label roll guard
- 9. Label supply spindle
- 10. Ribbon supply spindle
- 11. Damper
- 12. Label guide

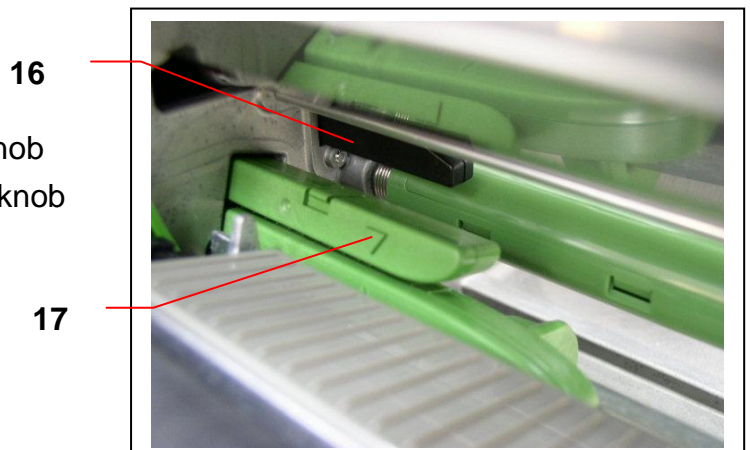
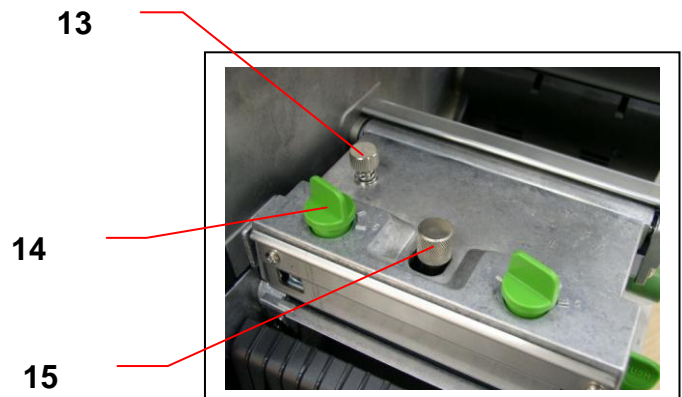

2.2.3 Rear View



1. Fan-fold paper entrance chute
2. Centronics interface
3. USB interface
4. RS-232C interface
5. Power jack socket
6. GPIO interface
- *7. SD card slot
8. Ethernet interface
9. PS/2 interface
10. Power switch

Note:

1. SD card slot, Ethernet interface and PS/2 interface are standard interfaces for TTP-2410M/TTP-346M models, but optional for TTP-246M Plus/TTP-344M Plus models.
2. GPIO interface card includes SD card slot, Ethernet and PS/2 interfaces. So GPIO interface is a factory option for TTP-2410M/TTP-346M, but a dealer option for TTP-246M Plus/TTP-344M Plus models.

*** Recommended SD card specification.**

| SD card spec | SD card capacity | Approved SD card manufacturer |
|-------------------|------------------|-------------------------------|
| V1.0, V1.1 | 128 MB | SanDisk, Transcend |
| V1.0, V1.1 | 256 MB | SanDisk, Transcend, Panasonic |
| V1.0, V1.1 | 512 MB | SanDisk, Transcend, Panasonic |
| V1.0, V1.1 | 1 GB | SanDisk, Transcend, Panasonic |
| V2.0 SDHC CLASS 4 | 4 GB | |
| V2.0 SDHC CLASS 6 | 4 GB | SanDisk, Transcend, Panasonic |
| V1.0, V1.1 | microSD 128 MB | Transcend, Panasonic |

| | | |
|---|----------------|----------------------|
| V1.0, V1.1 | microSD 256 MB | Transcend, Panasonic |
| V1.0, V1.1 | microSD 512 MB | Panasonic |
| V1.0, V1.1 | microSD 1 GB | Transcend, Panasonic |
| V2.0 SDHC CLASS 4 | microSD 4 GB | Panasonic |
| V2.0 SDHC CLASS 6 | microSD 4 GB | Transcend |
| V1.0, V1.1 | miniSD 128 MB | Transcend, Panasonic |
| V1.0, V1.1 | miniSD 256 MB | Transcend, Panasonic |
| V1.0, V1.1 | miniSD 512 MB | Transcend, Panasonic |
| V1.0, V1.1 | miniSD 1 GB | Transcend, Panasonic |
| V2.0 SDHC CLASS 4 | miniSD 4 GB | Transcend |
| V2.0 SDHC CLASS 6 | miniSD 4 GB | |
| <ul style="list-style-type: none"> - The DOS FAT file system is supported for the SD card. - Folders/files stored in the SD card should be in the 8.3 filename format - The miniSD/microSD card to SD card slot adapter is required. | | |

2.3 Operator Controls



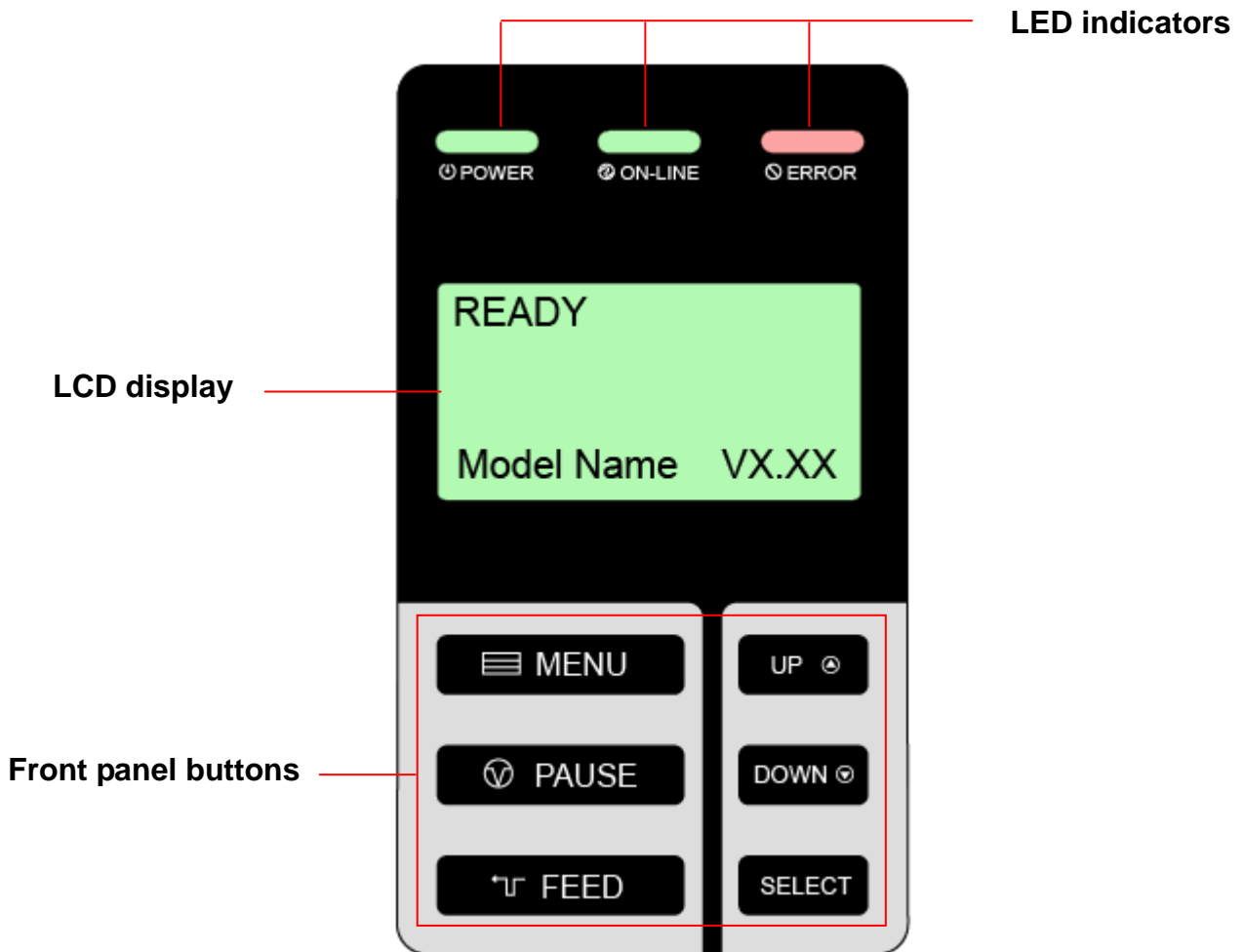

2.3.1 Front Panel Display



2.3.2 LED Indicators

| LED | Status | Indication |
|------------------|----------|--|
| ⏻ POWER | Off | The printer power is turned off |
| | On | The printer power is turned on |
| 📶 ON-LINE | On | Printer is ready |
| | Blinking | Pause Downloading data into printer. |
| 🚫 ERROR | Off | Printer is ready |
| | On | "Carriage open", "Cutter error" or "Clearing data" |
| | Blinking | "No paper", "Paper jam" or "No ribbon" |

2.3.3 Front Panel Keys

| Keys | Function |
|--|--|
|  MENU | 1. Enter the menu 2. Exit from a menu or cancel a setting and return to the previous menu |
|  PAUSE | Pause/Resume the printing process |
|  FEED | Advance one label |
| UP  | Scroll up the menu list |
| DOWN  | Scroll down the menu list |
| SELECT | Enter/Select cursor located option |

2.4 Setting Up the Printer

1. Place the printer on a flat, secure surface.
2. Make sure the power switch is off.
3. Connect the printer to the computer with the provided USB cable.
4. Plug the power cord into the AC power cord socket at the rear of the printer, and then plug the power cord into a properly grounded power outlet.

Note:

Please switch OFF printer power switch prior to plug in the power cord to printer power jack.

2.5 Installation of Ribbon

2.5.1 Loading the Ribbon

1. Lift open printer right side cover.
2. Push the print head release lever to open the print head mechanism.

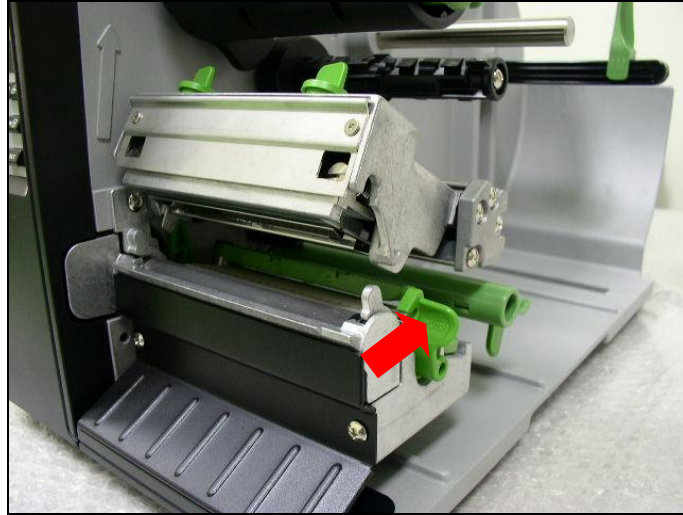

3. Install the ribbon onto the ribbon supply spindle.

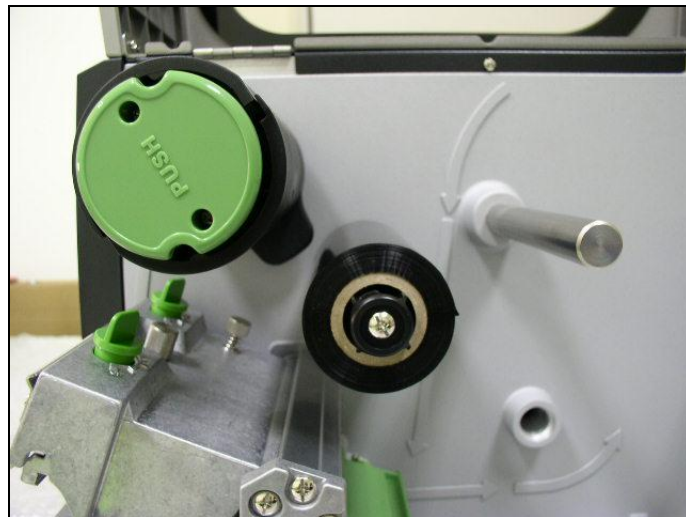

4. Thread the ribbon through the ribbon sensor slot and then through the open space in between print head and platen.

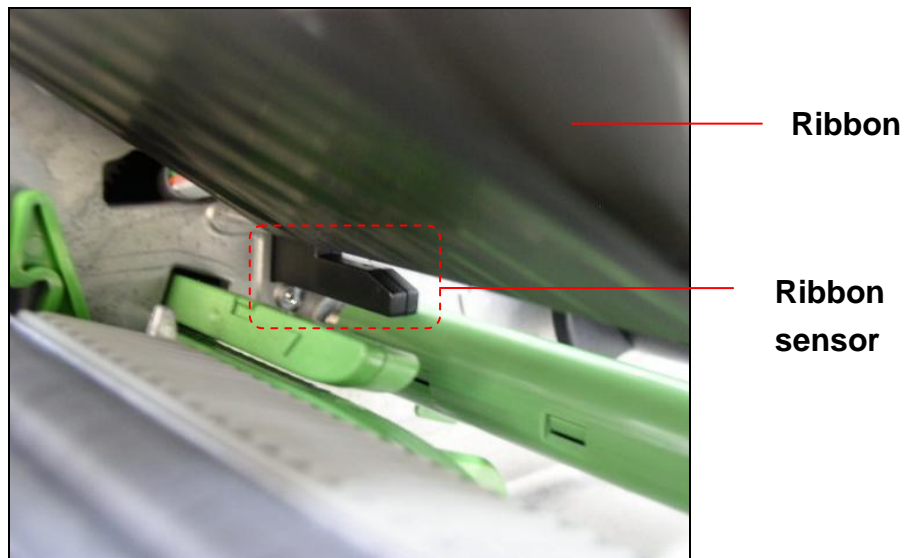

5. Wrap the ribbon onto the ribbon rewind spindle. Keep the ribbon flat and without wrinkles.
6. Wind the ribbon clockwise about 3~5 circles onto the ribbon rewind spindle until it is smooth and properly stretched.

Note: Please **DO NOT** push the ribbon release button when you are loading the ribbon. The ribbon release button is used to remove the used ribbon. ([Please refer to section 2.5.2](#))

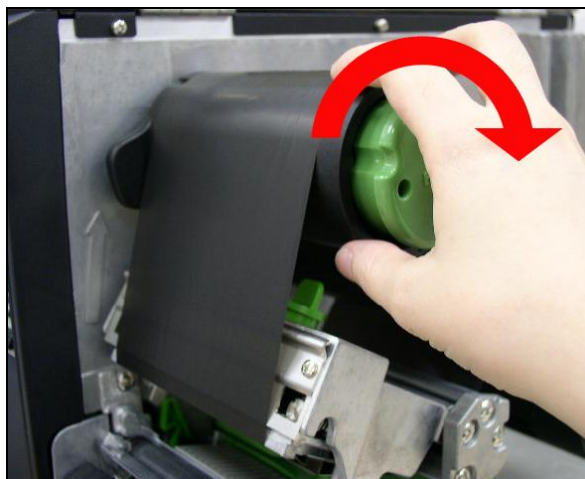

7. Close the print head mechanism making sure the latches are engaged properly.

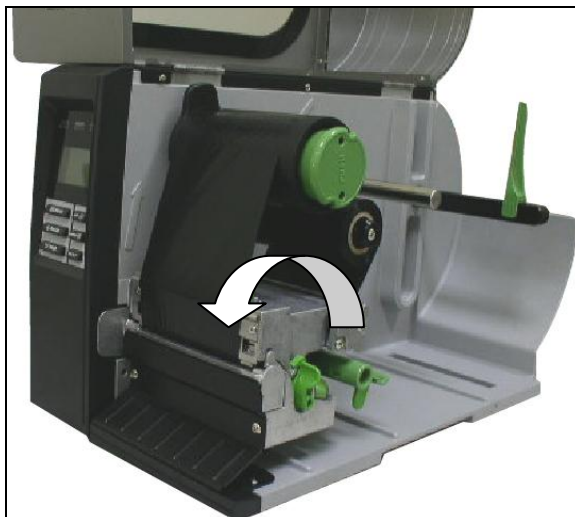

- **Loading path for ribbon**

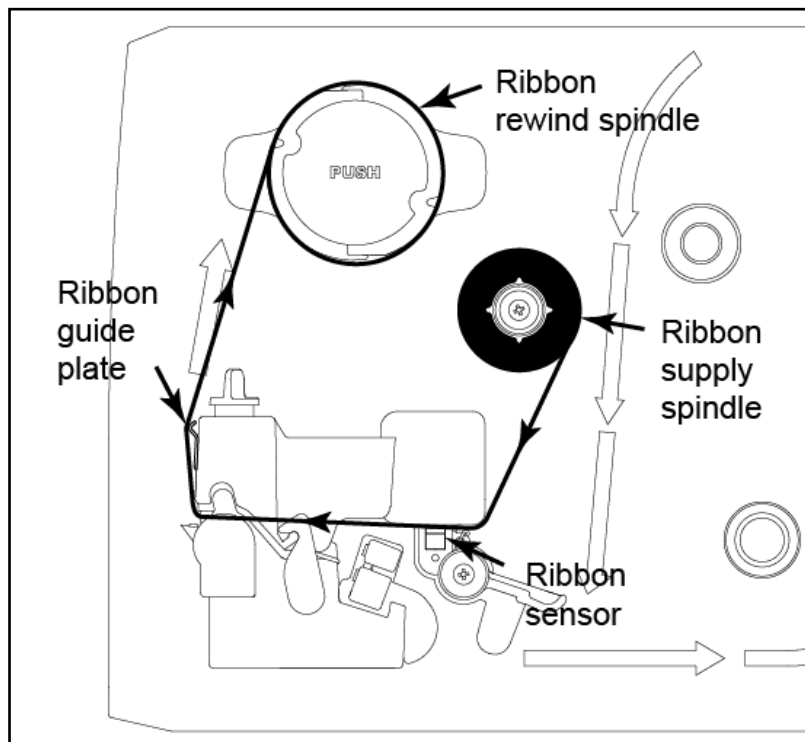

2.5.2 Remove Used Ribbon

1. Break the ribbon between ribbon guide plate and the ribbon rewind spindle.

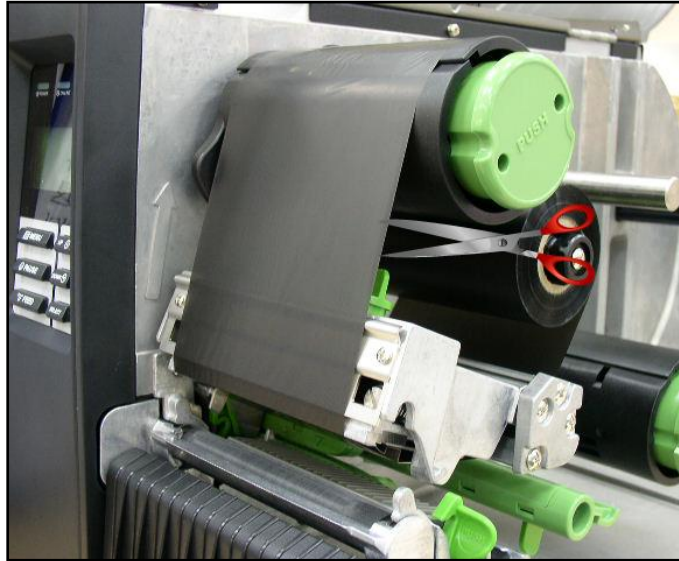

2. Push the ribbon release button to release the ribbon on the ribbon rewind spindle.



3. Then, slide off the ribbon from ribbon rewind spindle.



2.6 Installation of Media

2.6.1 Loading Roll Labels

1. Lift open printer right side cover.
2. Push the print head release lever to open the print head mechanism.



3. Move the label roll guard horizontally to the end of label spindle then flip down the label roll guard.

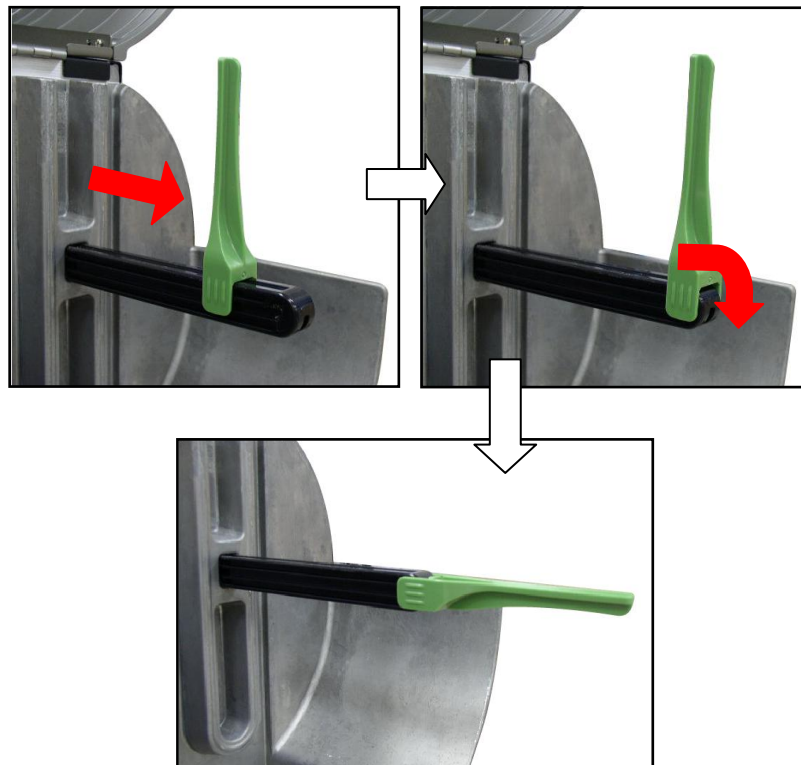

4. Place the roll of media on the label supply spindle. Flip up the label roll guard. Move the label roll guard horizontally to gently fit the width of label roll.

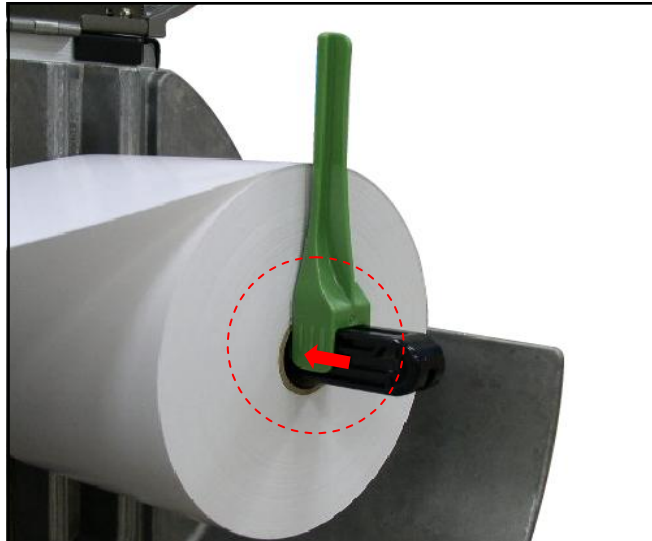

5. Pull label roll leading edge forward through the media guide bar, damper, media sensor and place the label leading edge onto the platen roller.

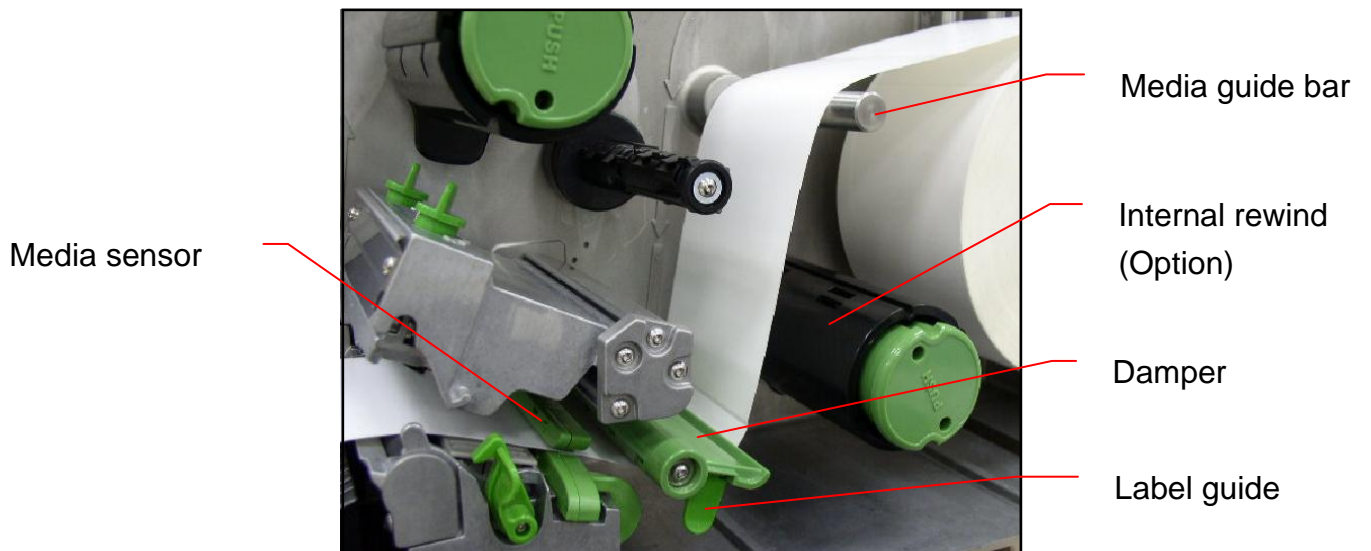

Note:

- * The sensor location is marked by a triangle mark ∇ at the sensor housing.
- * The media sensor position is moveable, please make sure the gap or black mark is at the location where media gap/black mark will pass through for sensing.



Media sensor location

6. Adjust the label guide to fit the width of the label.

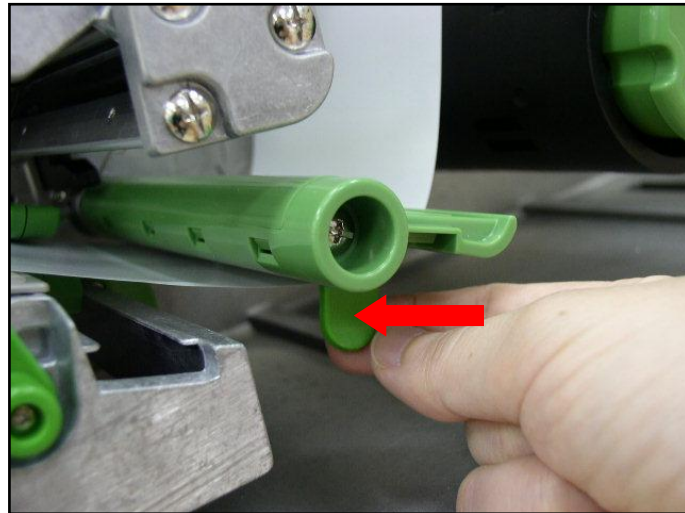

7. Close the print head mechanism making sure the latches are engaged properly.

8. Using the front display panel, set the media sensor type and calibrate the selected sensor. ([Please refer to section 3.1.2](#))

Note: Please calibrate the gap/black mark sensor when changing media.

- **Loading path for roll labels**

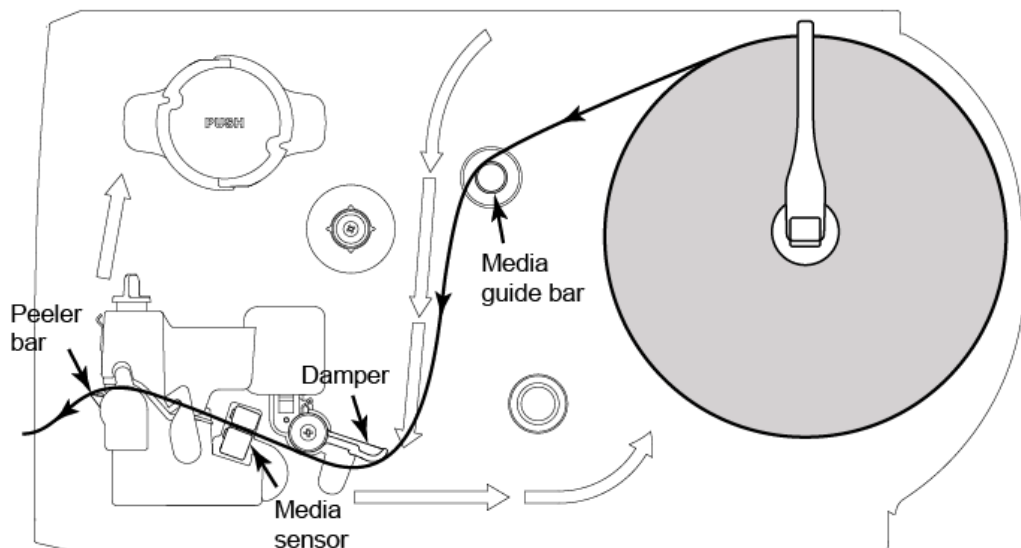

2.6.2 Loading Fan-fold Labels

Fan-fold media feeds through either the bottom or rear external label entrance chute.

1. Lift open printer right side cover.
2. Push the print head release lever to open the print head mechanism.



3. Insert the fan-fold media through the bottom or rear external label entrance chute.
4. Pull fan-fold label leading edge forward through the media guide bar, damper media sensor and place the label leading edge onto the platen roller.
5. Adjust the label guide by sliding to fit the paper width.
6. Close the print head mechanism making sure the latches are engaged properly.
7. Set the media sensor type and calibrate the selected sensor. ([Please refer to section 3.1.2](#))

Note: Please calibrate the gap/black mark sensor when changing media.

- **Loading path for fan-fold labels**

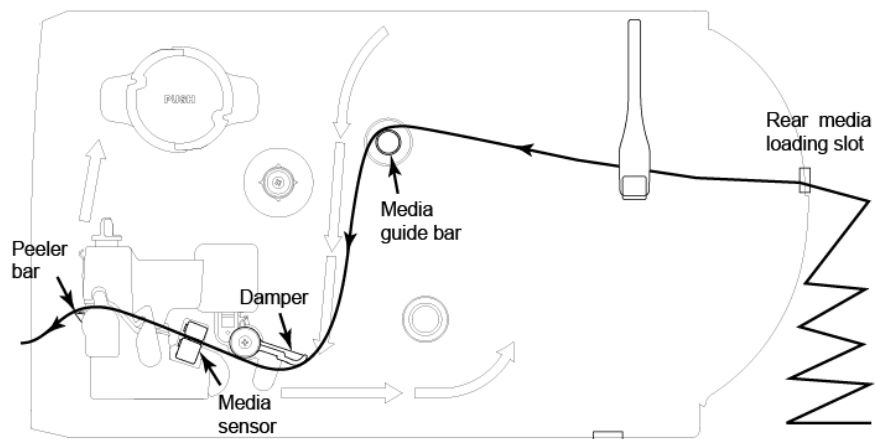

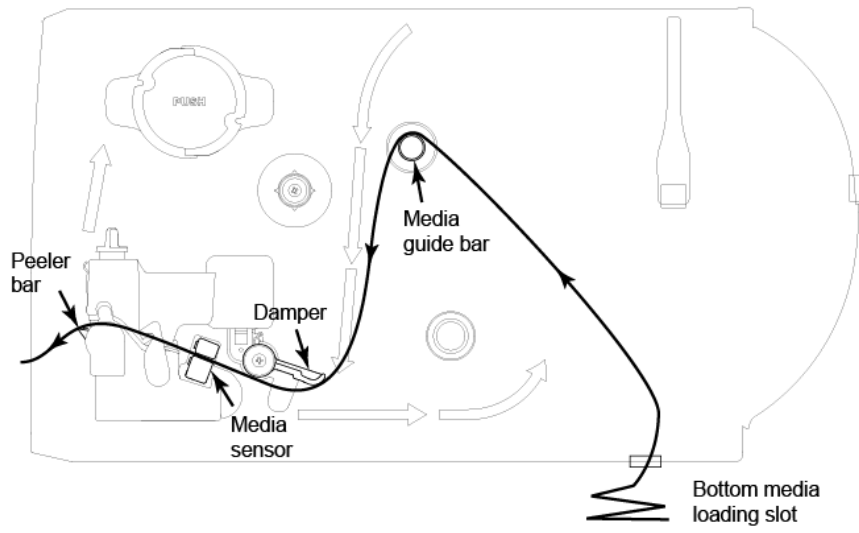

2.6.3 Loading Media in Peel-off Mode (Option)

1. Lift open printer right side cover.
2. Push the print head release lever to open the print head mechanism.
3. Move the label roll guard horizontally to the end of label spindle then flip down the label roll guard.
4. Place the roll of media on the label supply spindle. Flip up the label roll guard. Move the label roll guard horizontally to fit the width of label roll.
5. Pull label roll leading edge forward through the media guide bar, damper media sensor and place the label leading edge onto the platen roller.
6. Adjust the label guide to fit the width of the label.
7. Using the front display panel, set the media sensor type and calibrate the selected sensor. ([Please refer to section 3.1.2](#))
8. Then, pull approximately 650mm of label through the front of the printer.
9. Push down the peel-off roller release lever.

Peel-off roller
release lever

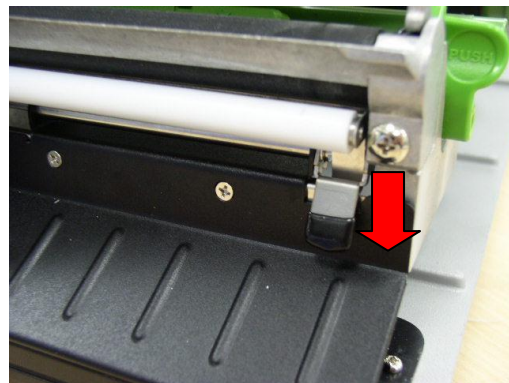

10. Feed the label between peel-off roller and platen roller.



Peel-off roller

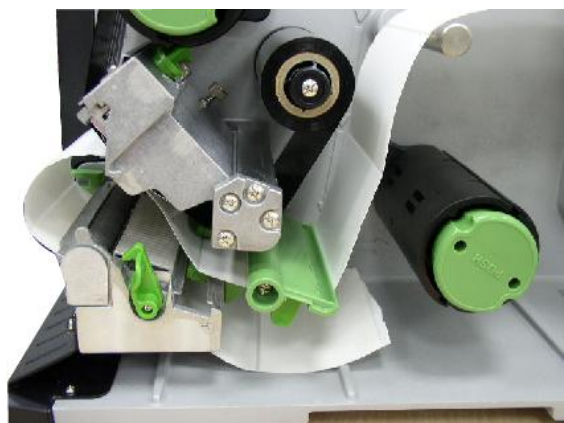

11. Wrap the label onto the internal rewind spindle and wind the spindle counter-clockwise about 3~5 circles until the label is properly stretched.

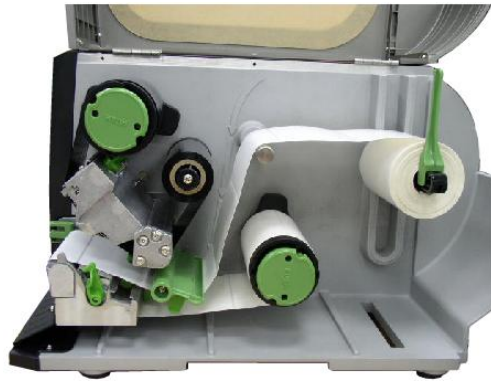

12. Lift up the peel-off roller release lever and close the print head mechanism.

13. Move the peel-off sensor toward the paper exit chute.

Peel-off sensor



14. Peeling will automatically start. Press the FEED button to test.

Label

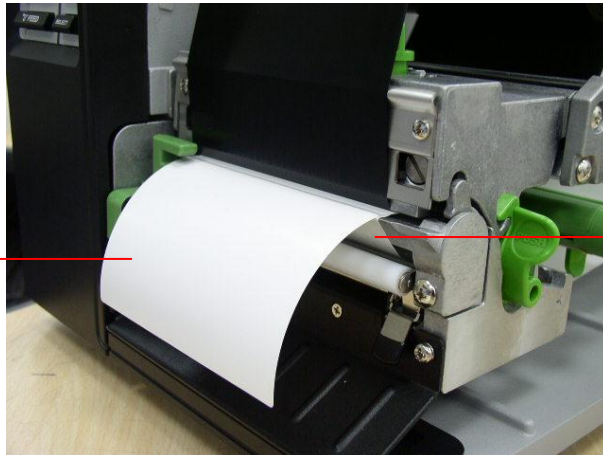

Liner

Note: Please calibrate the gap/black mark sensor when changing media.

2.6.4 Remove Liner from Internal Rewind (Option)

1. Break the liner between peel-off roller and the internal rewind spindle.

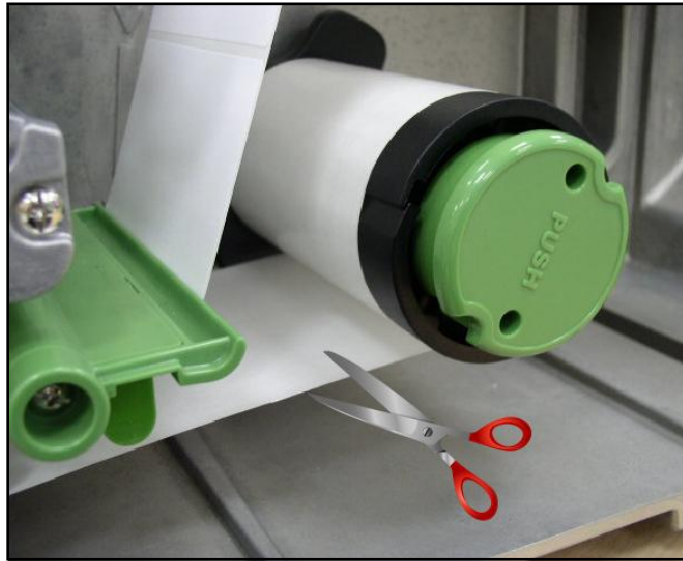

2. Push the liner release button to release the liner on the internal rewind spindle.



3. Then, slide off the liner from internal rewind spindle.



2.6.5 Loading Media in Rewind Liner with Label Mode (Option)

This mode can rewind the media including liner and label on the rewind spindle.

1. Lift open printer right side cover.
2. Insert the supply holder guide and paper core into the internal rewind for 1" core label roll.

Insert the supply holder guide, 3" label core adapter and paper core into the internal rewind for 3" core label roll.

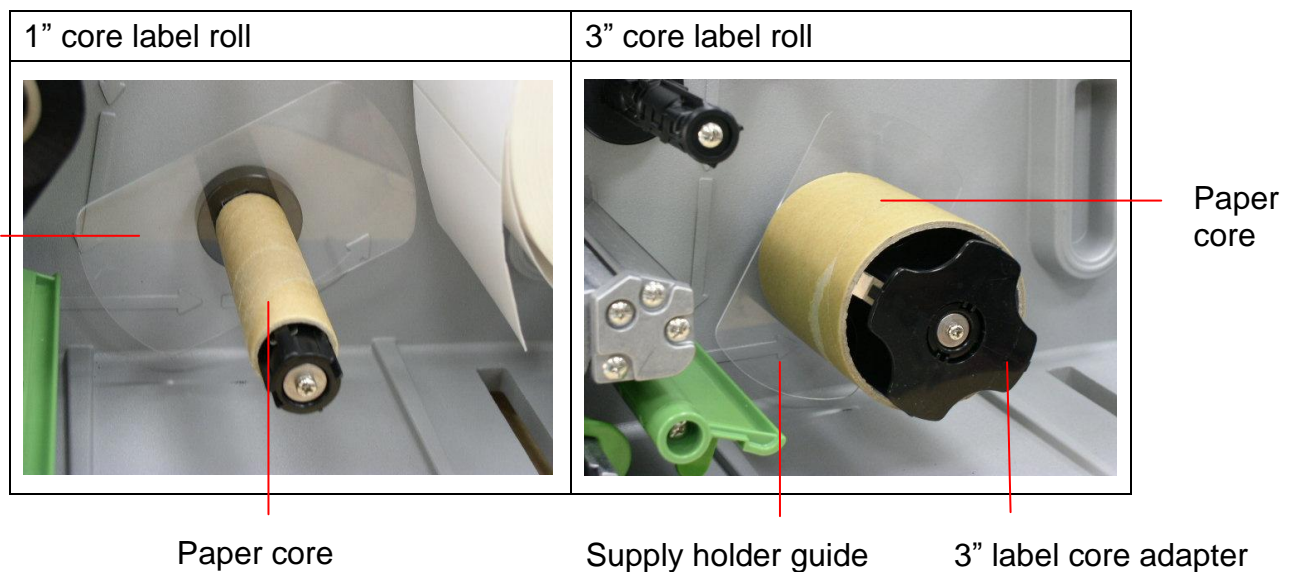

3. Insert media into the printer label spindle. Pull label roll leading edge forward through the media guide bar, damper media sensor and place the label leading edge onto the platen roller. ([Please refer to section 2.6.1](#))
4. Then, pull approximately 650mm of label through the label redirect front panel.
5. Wrap the label onto the internal rewind spindle and stick the label onto the paper core.

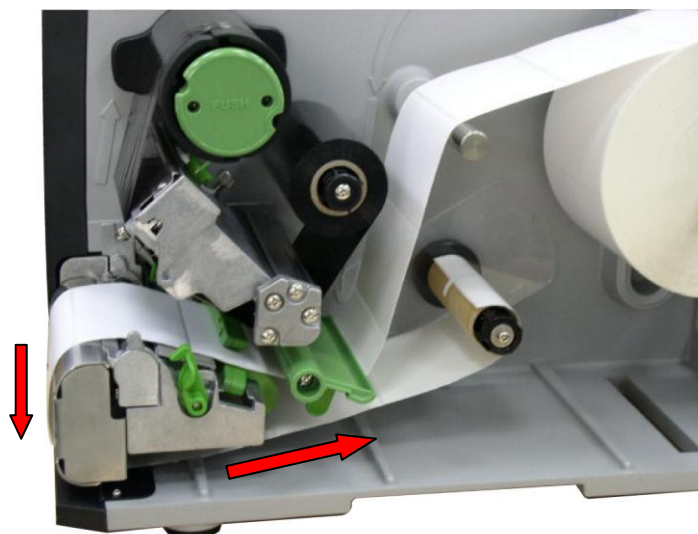

6. Insert another supply holder guide into the internal rewind for 1" core label roll.

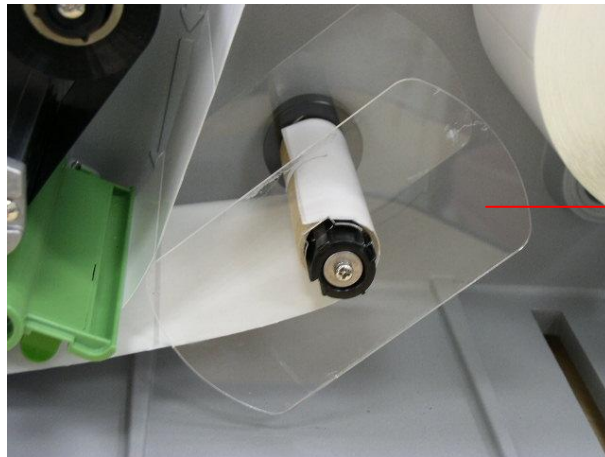

Supply holder guide

7. Using the LCD panel set the media sensor type and calibrate the selected sensor.
(Please refer to section 3.1.2)

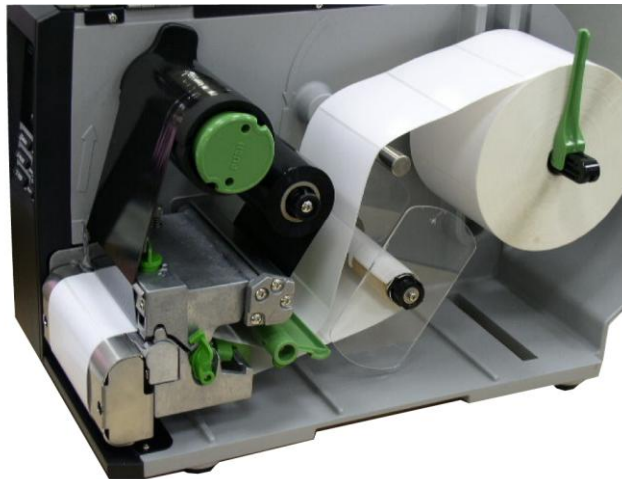

Note: Please calibrate the gap/black mark sensor when changing media.

2.6.6 Remove Labels from Internal Rewind (Option)

1. Slide off the labels with supply holder guides from internal rewind spindle.



2.7 Adjustment Knob

2.7.1 Print head Pressure Adjustment Knob

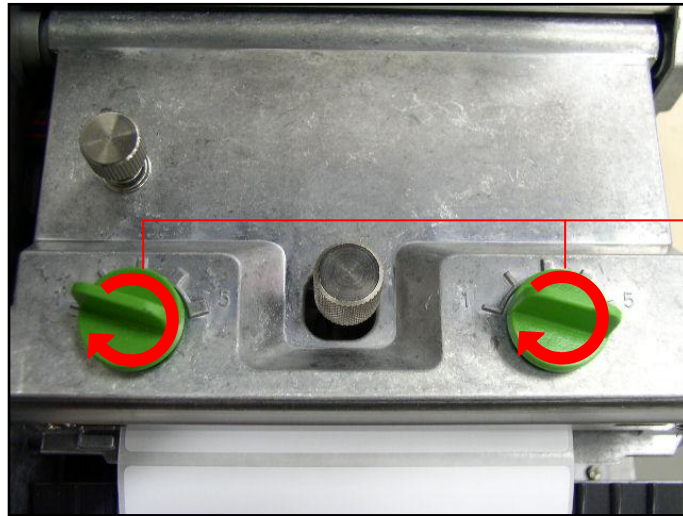

Print head pressure adjustment knobs

The print head pressure adjustment knob has 5 levels of adjustment. Because the printer's paper alignment is to the left side of mechanism, different media widths require different pressure to print correctly. Therefore it may require to adjust the pressure knob to get your best print quality. For example, if the label width is 4", adjust both print head pressure adjustment knobs to the same level. If the label is less than 2" wide, increase the left side print head pressure by rotating the adjustment knob clockwise and decrease the right side pressure by rotating the adjustment knob counter-clockwise to level 1.

2.7.2 Print Head Burn Line Adjustment Knob

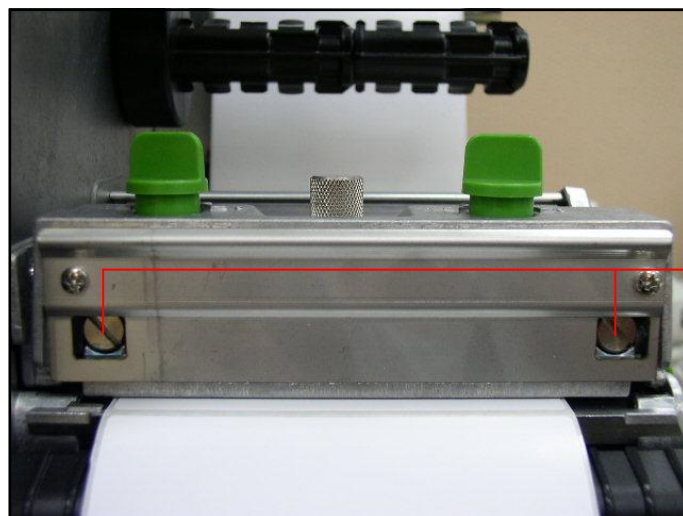

Print head burn line adjustment knobs

The print head burn line adjustment knobs are used to fine tune the print quality for

different thickness of media. Turning the knobs adjusts the print head's burn line forward or backward as it relates to the platen roller.

Caution: Incorrectly adjusting these knobs can lead to poor print quality and may cause damage to the printer. Proceed with caution.

The print head burn line default is set for general purpose printing media (plain paper and paper thickness less than 0.20mm).



Poor print quality when using paper thicker than 0.20mm may be due to the print head burn line not being at the optimized position. To improve the print quality, increase the head pressure or adjust the knobs counter-clockwise to move print head burn line toward the paper out direction then print again. Continue to adjust the burn line position and test print as necessary until the printout image is clear.

2.8 Using the Keyboard with PS/2 Interface (Optional for TTP-246M

Plus/TTP-344M Plus models)

1. Turn off the power of printer.
2. Plug the keyboard with PS/2 interface cable into PS/2 connector on the rear of the printer.
3. Turn on the printer.
4. After pressing the **F1** key of the keyboard, the LCD of printer will display as following.



```
File List      2/4
  DRAM
> FLASH
  CARD
```

5. Use up  or down  key of the keyboard to move “>” cursor and to select either DRAM, FLASH or CARD that you previously saved file in and press **Enter** key of the keyboard to list files.
6. Select the file and press **Enter** key to execute the .BAS file.

```
FLASH File List
  TEST1.BAS
> TEST2.BAS
  TEST3.BAS
```

7. Then, you can type the words or the number of the copy from keyboard by your .BAS file program.

Press **F1** key of the keyboard to start this function.

Press up  or down  key of the keyboard to move cursor of printer LCD display to select the option.

Press **Esc** key of the keyboard to return the previous menu.

Press **Enter** key of the keyboard to enter/execute cursor located option.

Press **Ctrl + C** keys of the keyboard to restart the printer and back to “Ready” state.

Note: PS/2 interface is a standard interface for TTP-2410M/TTP-346M models, but optional for TTP-246M Plus/TTP-344M Plus models.

3. Menu Function

Main Menu Overview

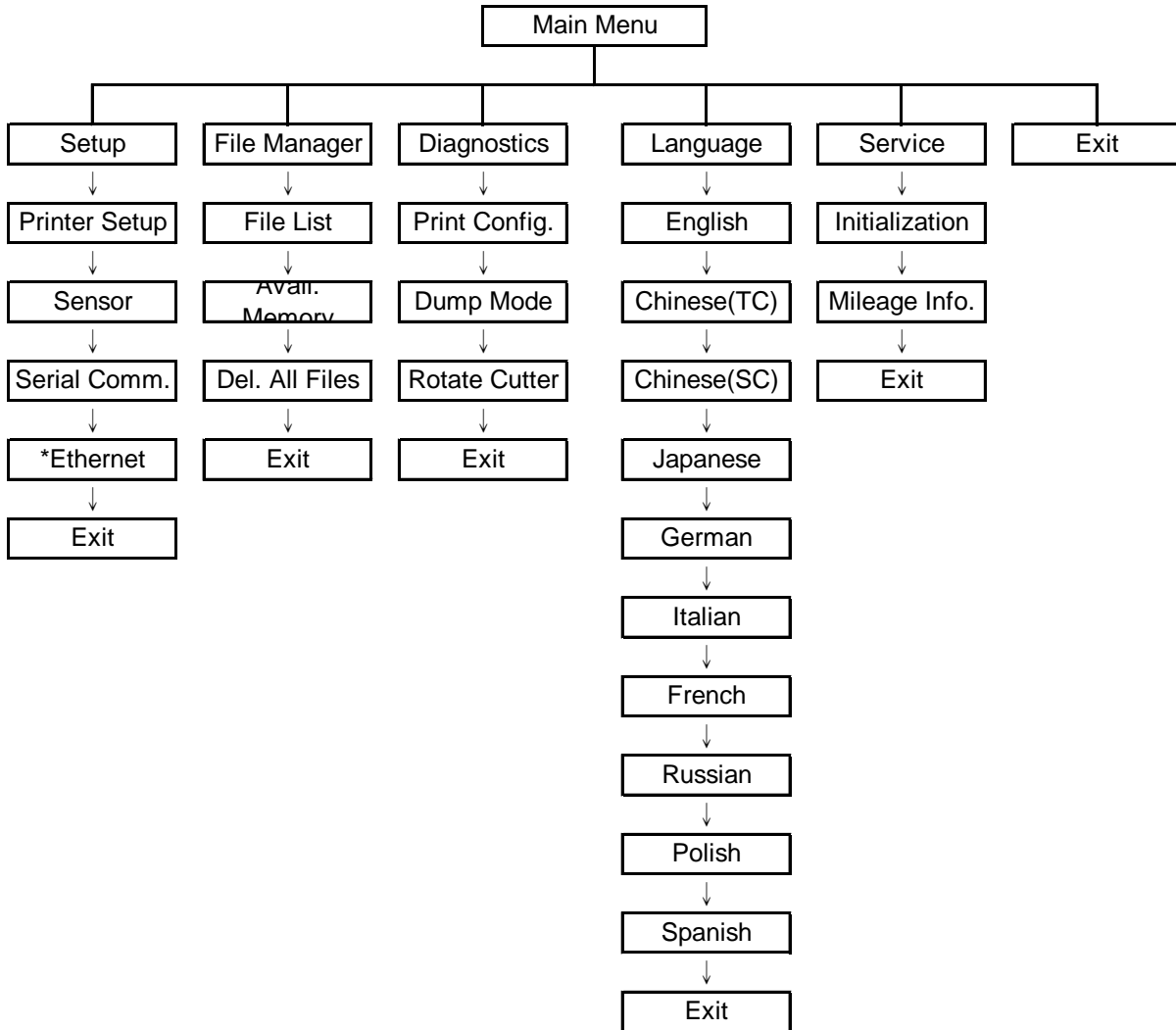

Notice:

- * The Ethernet function is available for TTP-2410M series only and option for TTP-246M Plus series.
- * Ethernet function is available on the LCD display when Ethernet card is installed.

3.1 Setup Menu Overview

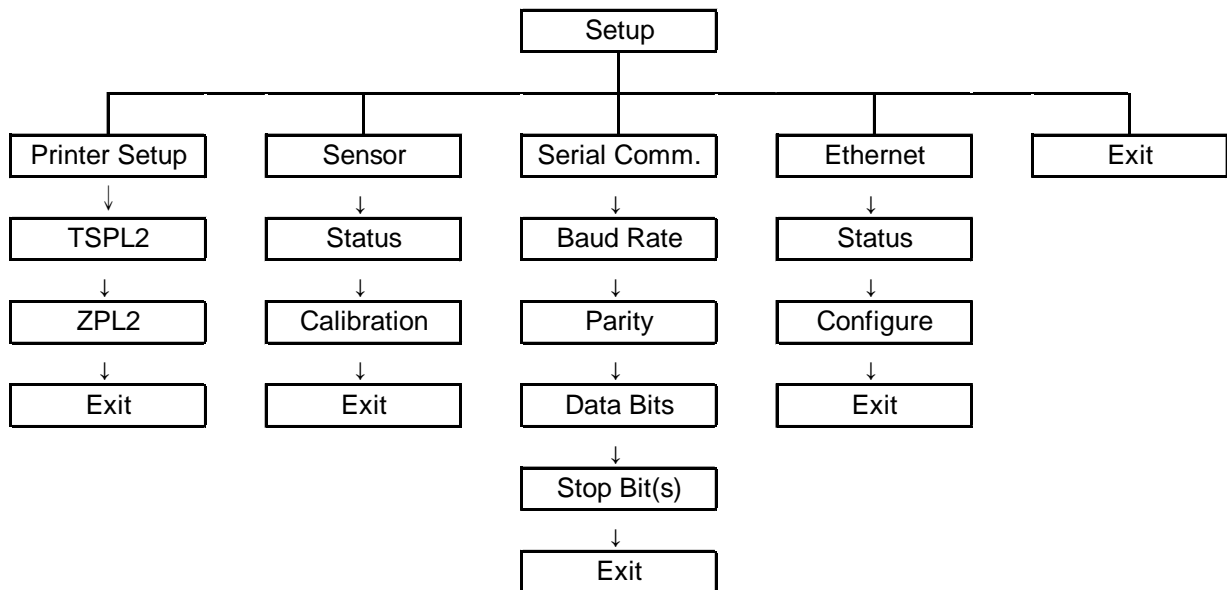

Notice:

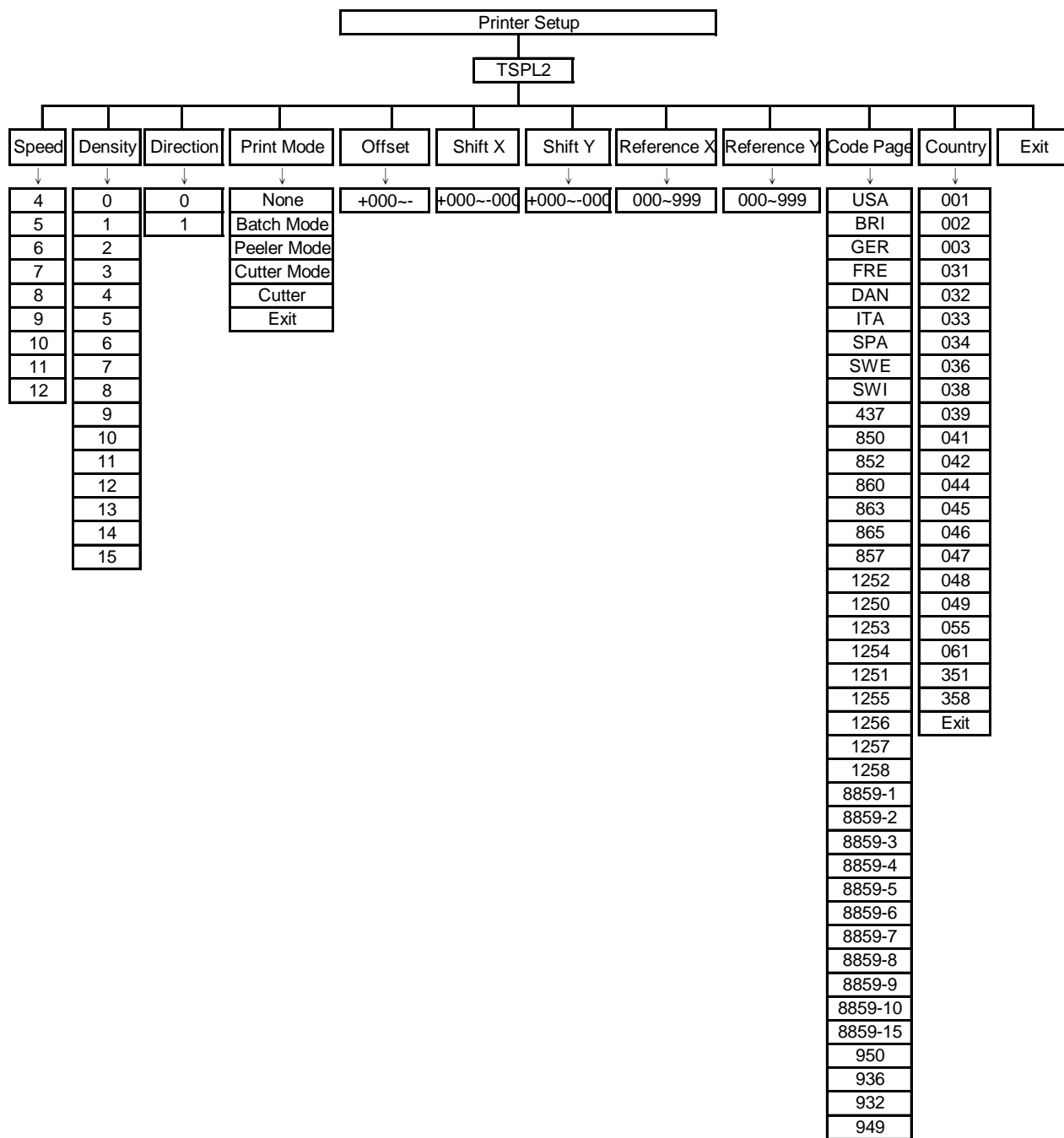

- * The Ethernet function is available for TTP-2410M series only and option for TTP-246M Plus series.
- * Ethernet function is available on the LCD display when Ethernet card is installed.

3.1.1-1 Printer Setup (TSPL2)

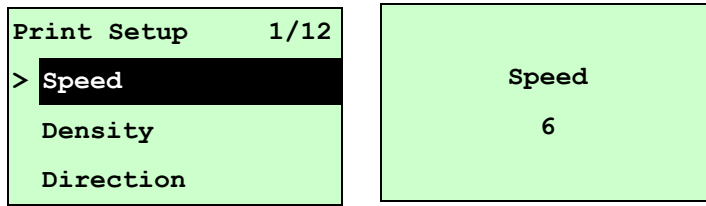

3.1.1-1.1 Speed:





Use this option to setup print speed. The each increment/decrement is 1 ips. Press **UP**  key to raise the print speed, and press **DOWN**  key to decrease print speed. Press **SELECT** key to set it into printer. Press  **MENU** key to cancel the setting and return to the previous menu.

Note: If printing from enclosed software/driver, the software/driver will send out the SPEED command, which will overwrite the setting set from the front panel.

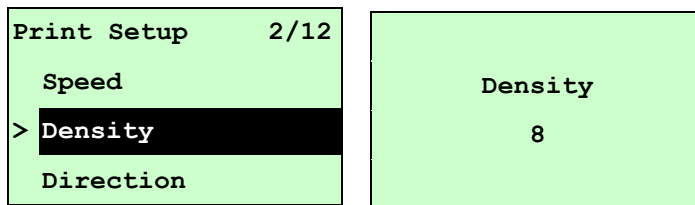
3.1.1-1.2 Density:



Use this option to setup printing darkness. The available setting is from 0 to 15, and the step is 1. Printer default density is 8. You may need to adjust your density based on selected media.



Press **UP**  and **DOWN**  to increase/decrease the printing darkness. Press **SELECT** key to enable the setting. Press  **MENU** key to cancel the setting and return to the previous menu.

Note: If printing from enclosed software/driver, the software/driver will send out the DENSITY command, which will overwrite the setting set from the front panel.

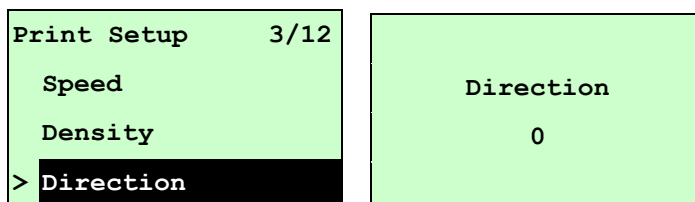
3.1.1-1.3 Direction:



The direction setting value is either 1 or 0. Use this option to setup the printout direction. Printer default printout direction is DIRECTION 0.

Press **UP**  key to set the direction as 1, and **DOWN**  to set it as 0, and **SELECT** key to enable the setting. Press  **MENU** key to cancel the setting and

return to the previous menu.

The following 2 figures are the printouts of DIRECTION 0 and 1 for your reference.

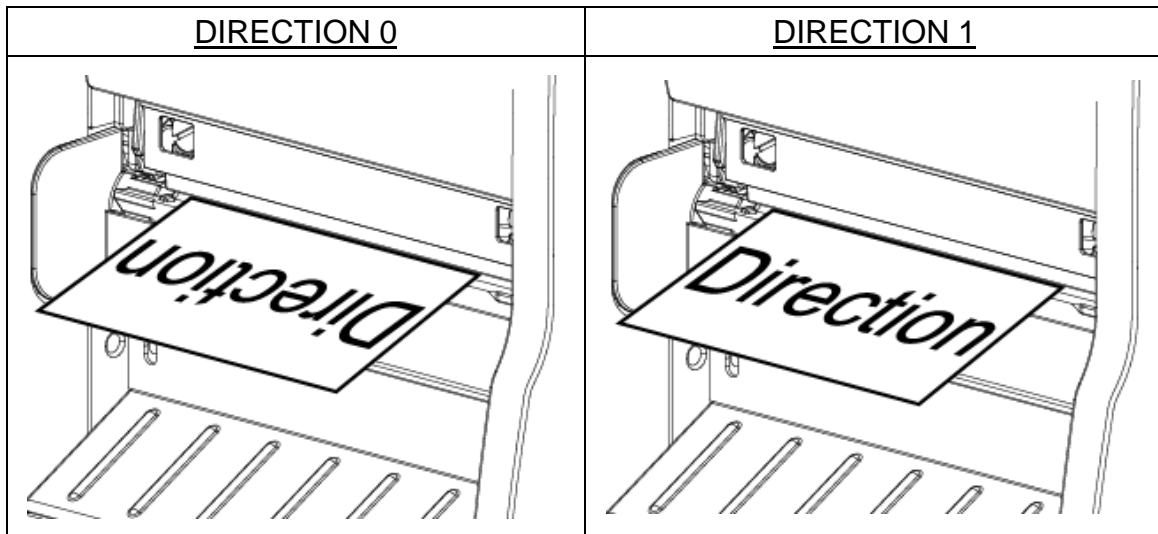

Note: If printing from enclosed software/driver, the software/driver will send out the command, which will overwrite the setting set from the front panel.

3.1.1-1.4 Print Mode: (None/Batch Mode/Peeler Mode/Cutter Mode/Cutter Batch)

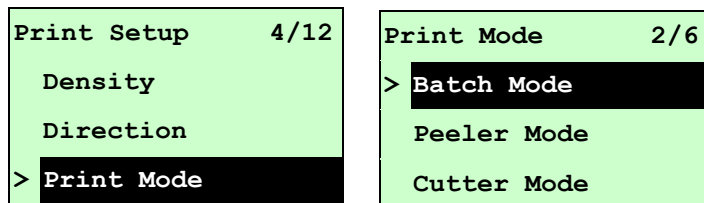

This option is used to set the print mode. Printer default setting is Batch Mode. When enter this list, the print mode in the right side of “>” icon is the printer current setting. Press **UP** ⏶ and **DOWN** ⏷ to select the different print mode and press **SELECT** button to enable the setting. Press **MENU** key to cancel the setting and return to the previous menu.

| Printer Mode | Description |
|--------------|--|
| None | Next label top of form is aligned to the print head burn line location. (Tear Off Mode) |
| Batch Mode | Once image is printed completely, label gap/black mark will be fed to the tear plate location for tear away. |
| Peeler Mode | Enable the label peel off mode. |
| Cutter Mode | Enable the label cutter mode. |

| | |
|--------------|--|
| Cutter Batch | Cut the label once at the end of the printing job. |
|--------------|--|

Note: If printing from enclosed software/driver, the software/driver will send out the command, which will overwrite the setting set from the front panel.

3.1.1-1.5 Offset:

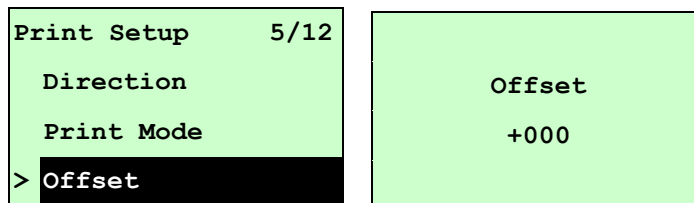

This option is used to fine tune media stop location. Press the **DOWN** Ⓞ button to move the cursor from left digit to right digit, and press the **UP** Ⓞ button to set the value from “+” to “-” or “0” to “9”. Press the **SELECT** button to set the value into printer. Press **MENU** key to cancel the setting and return to the previous menu. The default value is +000.

Note: If printing from enclosed software/driver, the software/driver will send out the OFFSET command, which will overwrite the setting set from the front panel.

3.1.1-1.6 Shift X & Shift Y:

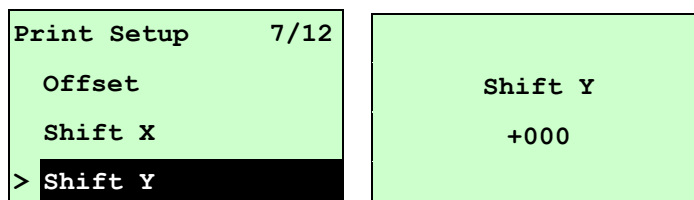

This option is used to fine tune print position. Press the **DOWN** Ⓞ button to move the cursor from left digit to right digit, and press the **UP** Ⓞ button to set the value from “+” to “-” or “0” to “9”. Press the **SELECT** button to set the value into printer. Press **MENU** key to cancel the setting and return to the previous menu. The default value is +000.

Note: If printing from enclosed software/driver, the software/driver will send out the SHIFT command, which will overwrite the setting set from the front panel.

3.1.1-1.7 Reference X & Reference Y:

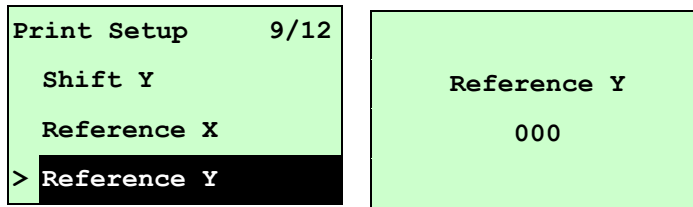

This option is used to set the origin of printer coordinate system horizontally and vertically. Press the **DOWN** Ⓞ button to move the cursor from left digit to right digit, and press the **UP** Ⓞ button to set the value from “0” to “9”. Press the **SELECT** button to set the value into printer. Press **MENU** key to cancel the setting and return to the previous menu. The default value is 000.

Note: If printing from enclosed software/driver, the software/driver will send out the REFERENCE command, which will overwrite the setting set from the front panel.

3.1.1-1.8 Code Page:

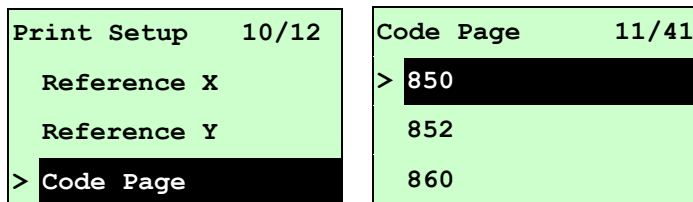

Use this option to set the code page of international character set. For more information about code page, please to refer the programming manual.

When enter the code page list, the code page in the right side of “>” icon is the printer current setting.

Press the **UP** Ⓞ and **DOWN** Ⓞ to select the code page, and press the **SELECT** button to enable the setting. Press **MENU** key to cancel the setting and return to the previous menu.

Note: If printing from enclosed software/driver, the software/driver will send out the command, which will overwrite the setting set from the front panel.

| 7-bit | | 8-bit | |
|----------------|-----------------------------|------------------|-----------------------------|
| code page name | International Character Set | code page number | International Character Set |
| USA | USA | 437 | United States |
| BRI | British | 850 | Multilingual |
| GER | German | 852 | Slavic |
| FRE | French | 860 | Portuguese |
| DAN | Danish | 863 | Canadian/French |
| ITA | Italian | 865 | Nordic |

| | | | |
|-----|---------|--|--|
| SPA | Spanish | | |
| SWE | Swedish | | |
| SWI | Swiss | | |

| Windows Code Page (SBCS) | | Windows Code Page (DBCS) | |
|--------------------------|-----------------------------|--------------------------|-----------------------------|
| code page number | International Character Set | code page number | International Character Set |
| 1252 | Latin 1 | 950 | Traditional Chinese Big5 |
| 1250 | Central Europe | 936 | Simplified Chinese GBK |
| 1253 | Greek | 932 | Japanese Shift-JIS |
| 1254 | Turkish | 949 | Korean |
| 1251 | Cyrillic | | |
| 1255 | Hebrew | | |
| 1256 | Arabic | | |
| 1257 | Baltic | | |
| 1258 | Vietnam | | |

| ISO Code Page | | ISO Code Page | |
|----------------|-----------------------------|------------------|-----------------------------|
| code page name | International Character Set | code page number | International Character Set |
| 8859-1 | Latin 1 | 8859-7 | Greek |
| 8859-2 | Latin 2 | 8859-9 | Turkish |
| 8859-3 | Latin 3 | 8859-10 | Latin 6 |
| 8859-4 | Baltic | 8859-15 | Latin 9 |
| 8859-5 | Cyrillic | | |

3.1.1-1.9 Country:

| | |
|-------------------|--------------|
| Print Setup 11/12 | Country 1/23 |
| Reference Y | > 001 |
| Code Page | 002 |
| > Country | 003 |

Use this option to set the country code for the LCD display. Press the **UP** ⬆ and **DOWN** ⬇ to select the country code, and press the **SELECT** button to set the

value into printer. When enter this list, the country code in the right side of “>” icon is the printer current setting. Press  **MENU** key to cancel the setting and return to the previous menu.

| Code | Country | Code | Country | Code | Country | Code | Country |
|-------------|-------------------------|-------------|-----------------|-------------|----------------|-------------|-------------------------|
| 001 | USA | 034 | Spanish (Spain) | 044 | United Kingdom | 055 | Brazil |
| 002 | Canadian-French | 036 | Hungarian | 045 | Danish | 061 | English (International) |
| 003 | Spanish (Latin America) | 038 | Yugoslavian | 046 | Swedish | 351 | Portuguese |
| 031 | Dutch | 039 | Italian | 047 | Norwegian | 358 | Finnish |
| 032 | Belgian | 041 | Switzerland | 048 | Polish | | |
| 033 | French (France) | 042 | Slovak | 049 | German | | |

3.1.1-2 Printer Setup (ZPL2)

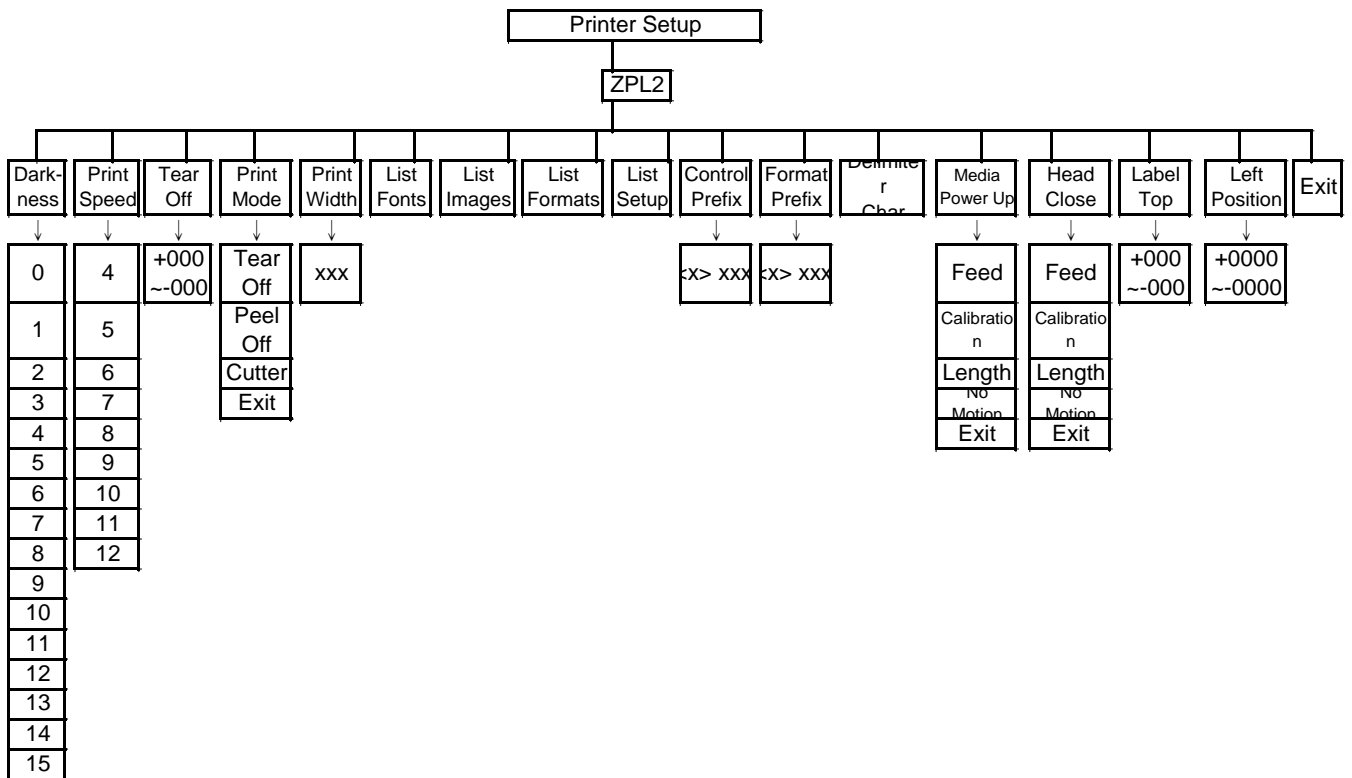

3.1.1-2.1 Darkness:

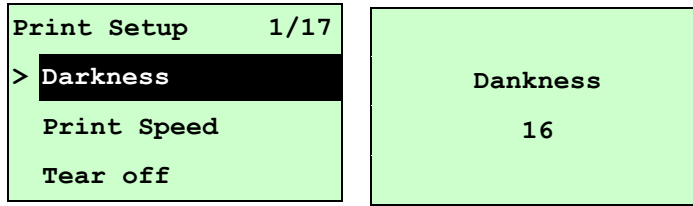

Use this option to setup printing darkness. The available setting is from 0 to 30, and the step is 1. Printer default density is 16. You may need to adjust your density based on selected media.

Press **UP** Ⓞ and **DOWN** Ⓞ to increase/decrease the printing darkness. Press **SELECT** key to enable the setting. Press **MENU** key to cancel the setting and return to the previous menu.

Note: If printing from enclosed software/driver, the software/driver will send out the command, which will overwrite the setting set from the front panel.

3.1.1-2.2 Print Speed:

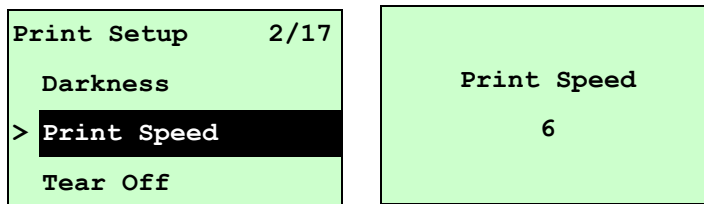

Use this option to setup print speed. The each increment/decrement is 1 ips. Press **UP** Ⓞ key to raise the print speed, and press **DOWN** Ⓞ key to decrease print speed. Press **SELECT** key to set it into printer. Press **MENU** key to cancel the setting and return to the previous menu.

Note: If printing from enclosed software/driver, the software/driver will send out the command, which will overwrite the setting set from the front panel.

3.1.1-2.3 Tear Off:

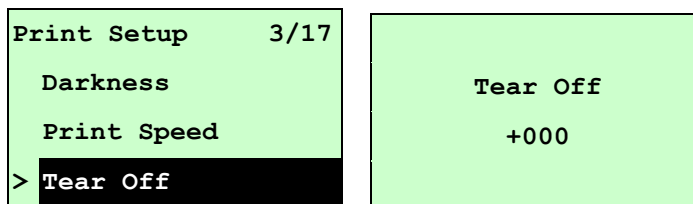

This option is used to fine tune media stop location. Press the **DOWN** Ⓞ button to

move the cursor from left digit to right digit, and press the **UP** Ⓞ button to set the value from “+” to “-” or “0” to “9”. Press the **SELECT** button to set the value into printer. Press **MENU** key to cancel the setting and return to the previous menu. The default value is +000.

Note: If printing from enclosed software/driver, the software/driver will send out the command, which will overwrite the setting set from the front panel.

3.1.1-2.4 Print Mode: (Tear Off / Peel Off / Cutter)

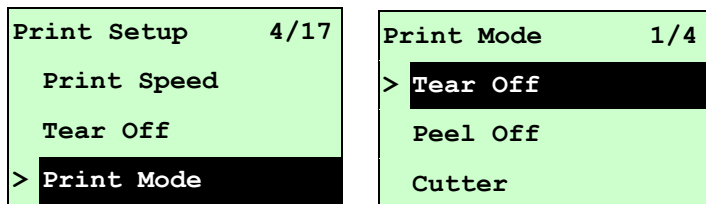

This option is used to set the print mode. Printer default setting is Tear Off. When enter this list, the print mode in the right side of “>” icon is the printer current setting. Press **UP** Ⓞ and **DOWN** Ⓞ to select the different print mode and press **SELECT** button to enable the setting. Press **MENU** key to cancel the setting and return to the previous menu.

| Printer Mode | Description |
|--------------|---|
| Tear Off | Next label top of form is aligned to the print head burn line location. |
| Peel Off | Enable the label peel off mode. |
| Cutter | Enable the label cutter mode. |

Note: If printing from enclosed software/driver, the software/driver will send out the command, which will overwrite the setting set from the front panel.

3.1.1-2.5 Print Width:

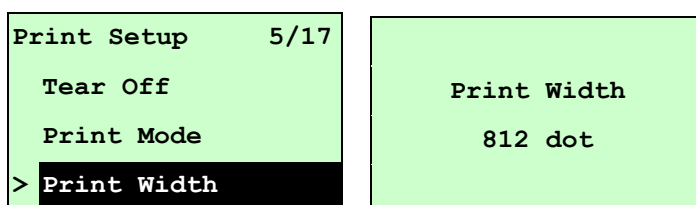

This option is used to set print width. Press the **DOWN** Ⓞ button to move the cursor from left digit to right digit, and press the **UP** Ⓞ button to set the value from “0” to

“9” or “dot” to “mm”. Press the **SELECT** button to set the value into printer. Press **MENU** key to cancel the setting and return to the previous menu.

Note: If printing from enclosed software/driver, the software/driver will send out the command, which will overwrite the setting set from the front panel.

3.1.1-2.6 List Fonts:

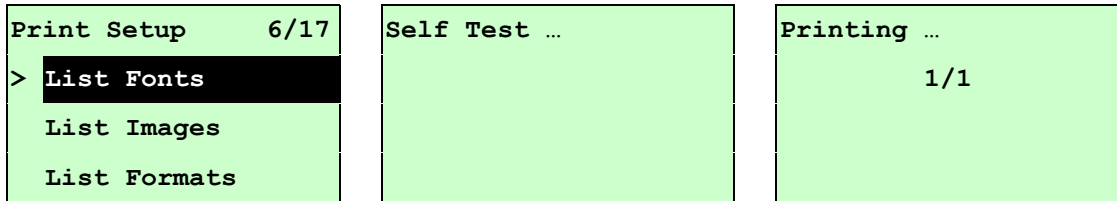

This feature is used to print current printer available fonts list to the label. The fonts stored in the printer's DRAM, Flash or optional memory card. Press **SELECT** button to print the list.

3.1.1-2.7 List Images:

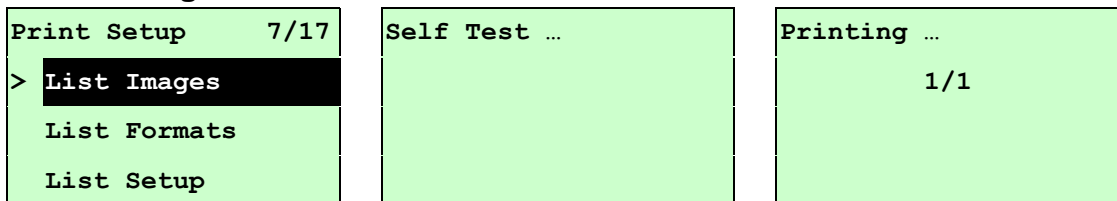

This feature is used to print current printer available images list to the label. The images stored in the printer's DRAM, Flash or optional memory card. Press **SELECT** button to print the list.

3.1.1-2.8 List Formats:

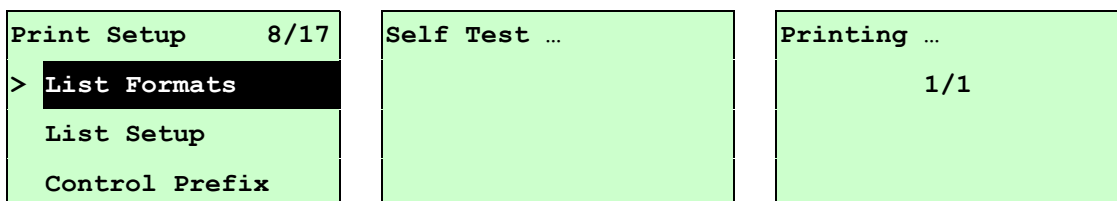

This feature is used to print current printer available formats list to the label. The formats stored in the printer's DRAM, Flash or optional memory card. Press **SELECT** button to print the list.

3.1.1-2.9 List Setup:

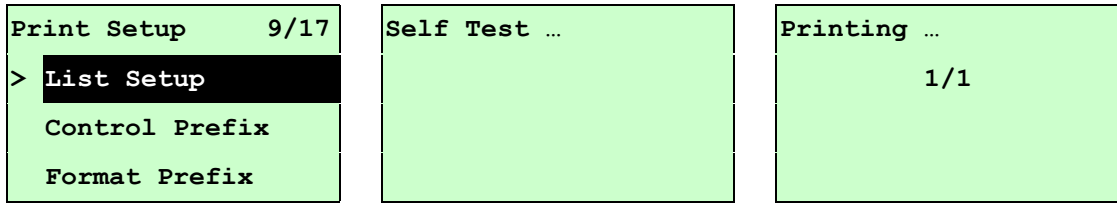

This feature is used to print current printer configuration to the label. Press **SELECT** button to print the list.

3.1.1-2.10 Control Prefix:

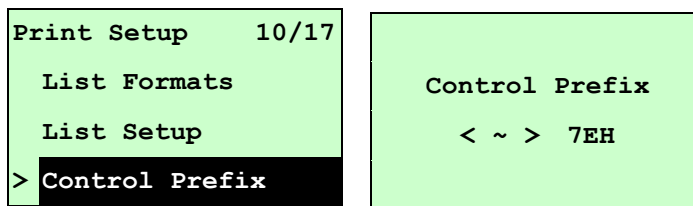

This option is used to set control prefix character. Press the **DOWN** Ⓞ button to move the cursor from left digit to right digit, and press the **UP** Ⓞ button to set the value from “0” to “9” or “A” to “F”. Press the **SELECT** button to set the value into printer. Press **MENU** key to cancel the setting and return to the previous menu.

3.1.1-2.11 Format Prefix:

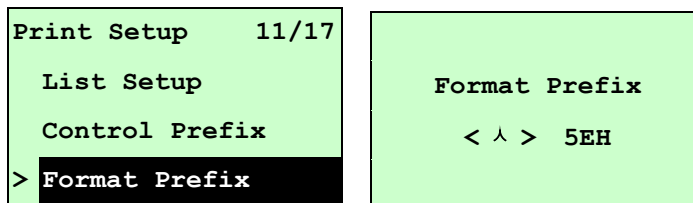

This option is used to set format prefix character. Press the **DOWN** Ⓞ button to move the cursor from left digit to right digit, and press the **UP** Ⓞ button to set the value from “0” to “9” or “A” to “F”. Press the **SELECT** button to set the value into printer. Press **MENU** key to cancel the setting and return to the previous menu.

3.1.1-2.12 Delimiter Char:

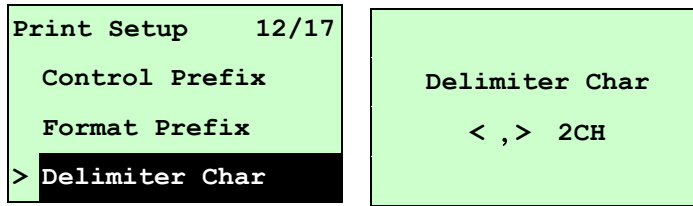

This option is used to set delimiter character. Press the **DOWN** Ⓞ button to move the cursor from left digit to right digit, and press the **UP** Ⓞ button to set the value from “0” to “9” or “A” to “F”. Press the **SELECT** button to set the value into printer. Press **MENU** key to cancel the setting and return to the previous menu.

3.1.1-2.13 Media Power Up:

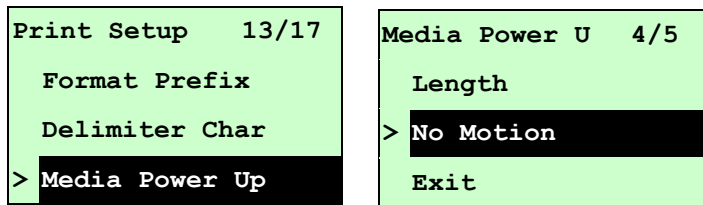

This option is used to set the action of the media when you turn on the printer. Printer default setting is No Motion. When enter this list, the print mode in the right side of “>” icon is the printer current setting. Press **UP** Ⓞ and **DOWN** Ⓞ to select the different print mode and press **SELECT** button to enable the setting. Press **MENU** key to cancel the setting and return to the previous menu.

| Selections | Description |
|-------------|---|
| Feed | Printer will advance one label |
| Calibration | Printer will calibration the sensor levels, determine length and feed label |
| Length | Printer determine length and feed label |
| No Motion | Printer will not move media |

3.1.1-2.14 Head Close:

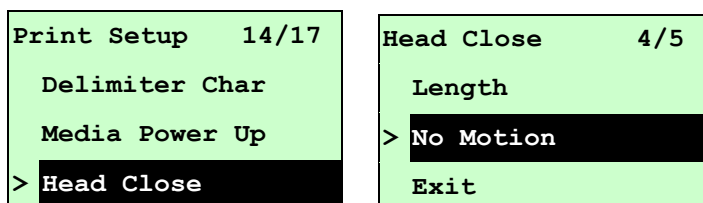

This option is used to set the action of the media when you close the printhead. Printer default setting is No Motion. When enter this list, the print mode in the right side of “>” icon is the printer current setting. Press **UP** ⏴ and **DOWN** ⏵ to select the different print mode and press **SELECT** button to enable the setting. Press **MENU** key to cancel the setting and return to the previous menu.

| Selections | Description |
|-------------|---|
| Feed | Printer will advance one label |
| Calibration | Printer will calibration the sensor levels, determine length and feed label |
| Length | Printer determine length and feed label |
| No Motion | Printer will not move media |

3.1.1-2.15 Label Top:

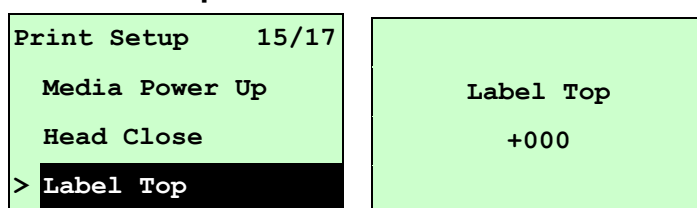

This option is used to adjust print position vertically on the label. Press the **DOWN** ⏵ button to move the cursor from left digit to right digit, and press the **UP** ⏴ button to set the value from “+” to “-” or “0” to “1/2”. Press the **SELECT** button to set the value into printer. Press **MENU** key to cancel the setting and return to the previous menu. The default value is +000 and range is -120 to +120 dots.

3.1.1-2.16 Left Position:

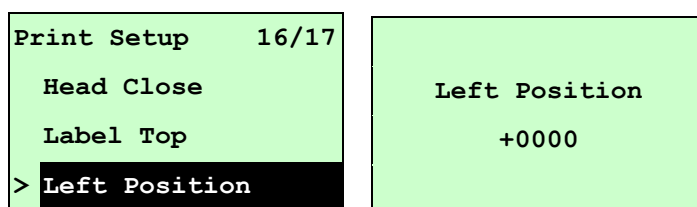

This option is used to adjust print position horizontally on the label. Press the **DOWN** ⏵ button to move the cursor from left digit to right digit, and press the **UP** ⏴ button to set the value from “+” to “-” or “0” to “9”. Press the **SELECT** button to set the value into printer. Press **MENU** key to cancel the setting and return to the previous menu. The default value is +0000 and range is -9999 to +9999 dots.

3.1.2 Sensor

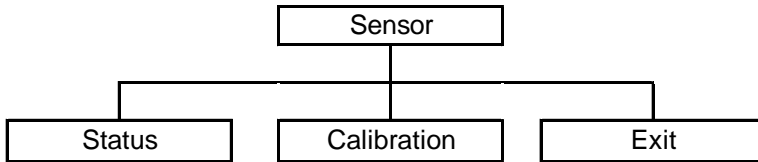

3.1.2.1 Status

This function is available to check the printer's sensor status. When enter the [Status] option, you will see following message.

| | |
|------------|-----|
| Paper Len. | 812 |
| Gap Size | 24 |
| Intensity | 3 |
| Ref. Level | 512 |

3.1.2.2 Calibration

This option is used to set the media sensor type and calibrate the selected sensor. We recommend to calibrate the sensor before printing when changing the media.

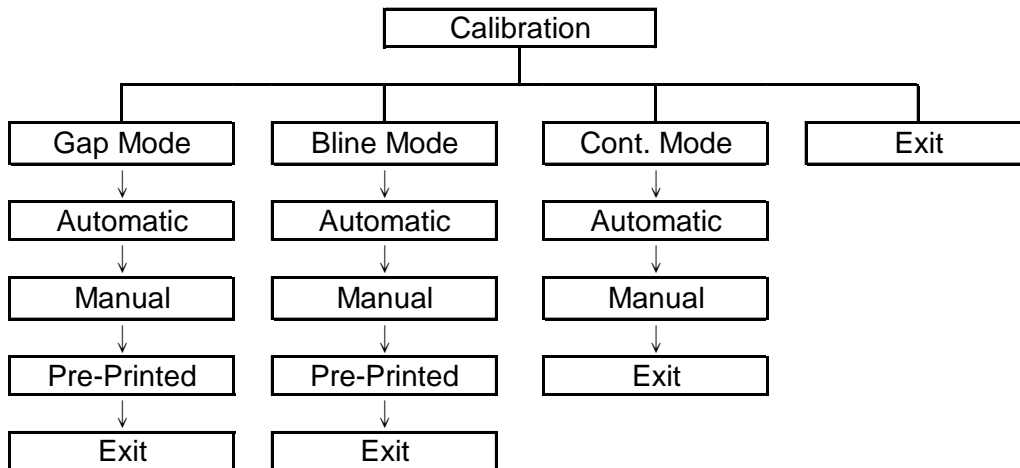

A. Gap Mode

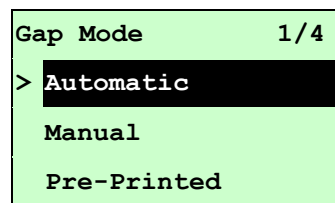
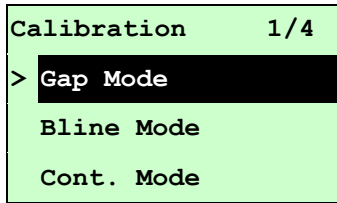

Press the **UP** ⤴ and **DOWN** ⤵ buttons to scroll the cursor to the media type and press the **SELECT** button to enter the sensor calibration mode.

Note: *If printing from enclosed software/driver, the software/driver will send out the GAP or BLINE command, which will overwrite the sensor type setting set from the front panel.*

A-1 Automatic

When enter the [Automatic] option, you will see following message, and printer will feed 2 to 3 gap labels to calibrate the sensor sensitivity automatically. When calibration is completed, the LCD screen will return to the previous menu.

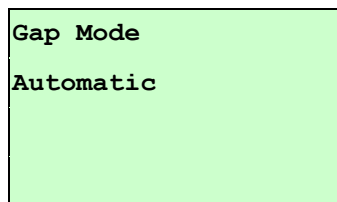

A-2 Manual

In case “Automatic” sensor calibration cannot apply to the media, please use “Manual” function to calibrate the gap sensor manually.

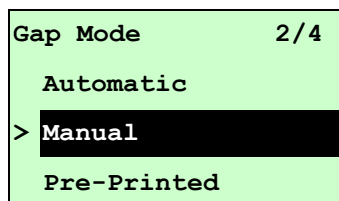

When enter [Manual] option, you will see following message. Please complete there steps :

| | |
|---------------------------------|---|
| <p>Paper Len. 00812 dot</p> | <ol style="list-style-type: none">1. Press the DOWN ⤵ button to move the cursor from left digit to right digit, and press the UP ⤴ button to set the value from “0” to “9” and the “dot/mm/ inch”. Press the SELECT button to set the paper length into the printer. |
|---------------------------------|---|

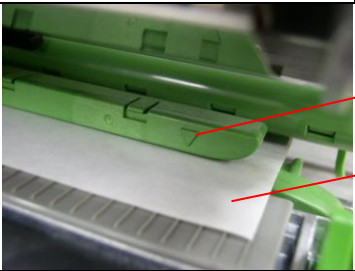
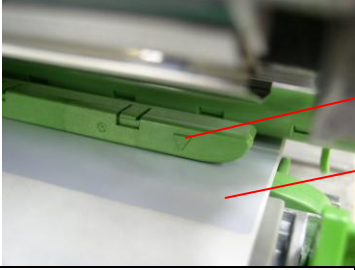
| | |
|---|--|
| <p style="text-align: center;">Gap Size 0024 dot</p> | <p>2. Press the DOWN ⏴ button to move the cursor from left digit to right digit, and press the UP ⏵ button to set the value from “0” to “9” and the “dot/mm/ inch”. Press the SELECT button to set the gap size into the printer.</p> |
| <p>Gap Mode Scan Backing Intensity x Ref. Level xxx</p> | <p>3. Open the print head mechanism, put the label backing (liner) under the media sensor. Press the SELECT button to set the value into the printer.</p> |
|  | <p>Media sensor Label backing (liner)</p> |
| <p>Gap Mode Scan Paper Intensity x Ref. Level xxx</p> | <p>4. Then, Put the label with liner under the media sensor. Press the SELECT button to set the value into the printer.</p> |
|  | <p>Media sensor Label with liner</p> |
| <p>Gap Mode Complete Intensity x Ref. Level xxx</p> | <p>5. The gap sensor calibration is complete. Press the SELECT button the LCD screen will return to the previous menu.</p> |

A-3 Pre-Printed

This function can set the paper length and gap size before auto-calibrate the sensor sensitivity. It can to get the sensor sensitivity accurately.

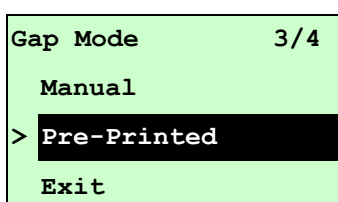

When enter [Pre-Printed] option, you will see following message. Please complete there steps :

| | |
|--|--|
| <p style="text-align: center;">Paper Len. 00812 dot</p> | <p>1. Press the DOWN ⤵ button to move the cursor from left digit to right digit, and press the UP ⤴ button to set the value from “0” to “9” and the “dot/mm/ inch”. Press the SELECT button to set the paper length into the printer.</p> |
| <p style="text-align: center;">Gap Size 0024 dot</p> | <p>2. Press the DOWN ⤵ button to move the cursor from left digit to right digit, and press the UP ⤴ button to set the value from “0” to “9” and the “dot/mm/ inch”. Press the SELECT button to set the gap size into the printer.</p> |
| <p>Gap Mode Pre-Printed</p> | <p>3. Then, printer will feed labels to calibrate the sensor sensitivity automatically. When calibration is completed, the LCD screen will return to the previous menu.</p> |

B. Bline Mode

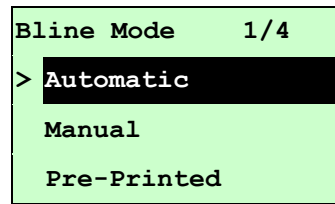
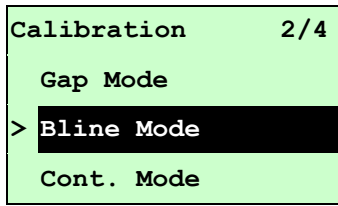

Press the **UP** ⤴ and **DOWN** ⤵ buttons to scroll the cursor to the sensor type. Press the **SELECT** button to enter the black-mark sensor calibration mode.

B-1 Automatic

When enter the [Automatic] option, you will see following message and printer will feed the black mark label to calibrate the sensor sensitivity automatically. When calibration process is completed, the LCD screen will return to the previous menu.

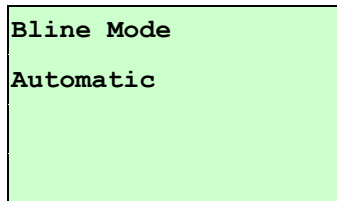

B-2 Manual

In case “Automatic” sensor calibration cannot apply to the media, please use “Manual” function to calibrate the bline sensor manually.

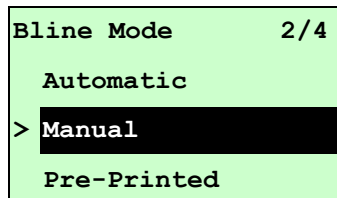

When enter [Manual] option, you will see following message. Please complete there steps :

| | |
|---------------------------------|--|
| <p>Paper Len. 00151 dot</p> | <p>1. Press the DOWN ⤵ button to move the cursor from left digit to right digit, and press the UP ⤴ button to set the value from “0” to “9” and the “dot/mm/ inch”. Press the SELECT button to set the paper length into the printer.</p> |
| <p>Bline Size 0024 dot</p> | <p>2. Press the DOWN ⤵ button to move the cursor from left digit to right digit, and press the UP ⤴ button to set the value from “0” to “9” and the “dot/mm/ inch”. Press the SELECT button to set the bline size into the printer.</p> |

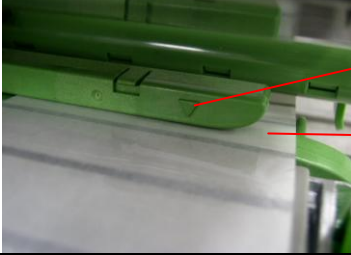
| | |
|--|---|
| <pre> Bline Mode Scan Mark Intensity x Ref. Level xxx </pre> | <p>3. Open the print head mechanism, put the black mark under the media sensor. Press the SELECT button to set the value into the printer.</p> |
|  | <p>Media sensor Black mark</p> |
| <pre> Bline Mode Scan Paper Intensity x Ref. Level xxx </pre> | <p>4. Then, put the label without black mark under the media sensor. Press the SELECT button to set the value into the printer.</p> |
|  | <p>Media sensor Label without black mark</p> |
| <p>Note: Normally, the value of "Ref. Level" for mark should be larger than paper for over 128. If the media sensor fails to do so, you have to manually change the Intensity by pressing UP Ⓢ and DOWN Ⓢ to reach the above value.</p> | |
| <pre> Bline Mode Complete Intensity x Ref. Level xxx </pre> | <p>5. The bline sensor calibration is complete. Press the SELECT button the LCD screen will return to the previous menu.</p> |

B-3 Pre-Printed

This function can set the paper length and gap size before auto-calibrate the sensor sensitivity. It can to get the sensor sensitivity accurately.

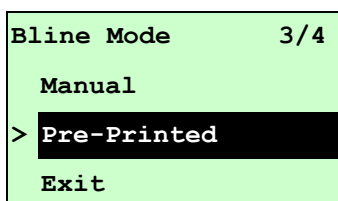

When enter [Pre-Printed] option, you will see following message. Please

complete these steps :

| | |
|-----------------------------------|--|
| <p>Paper Len. 00812 dot</p> | <p>1. Press the DOWN ⤵ button to move the cursor from left digit to right digit, and press the UP ⤴ button to set the value from "0" to "9" and the "dot/mm/ inch". Press the SELECT button to set the paper length into the printer.</p> |
| <p>Bline Size 0024 dot</p> | <p>2. Press the DOWN ⤵ button to move the cursor from left digit to right digit, and press the UP ⤴ button to set the value from "0" to "9" and the "dot/mm/ inch". Press the SELECT button to set the bline size into the printer.</p> |
| <p>Bline Mode Pre-Printed</p> | <p>3. Then, printer will feed labels to calibrate the sensor sensitivity automatically. When calibration is completed, the LCD screen will return to the previous menu.</p> |

C. Cont. Mode

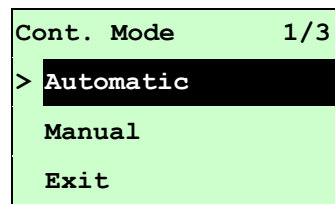
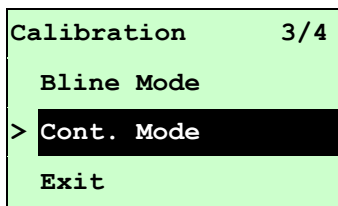

Press the **UP** ⬆ and **DOWN** ⬇ buttons to scroll the cursor to the sensor type. Press the **SELECT** button to enter the black-mark sensor calibration mode.

C-1 Automatic

When enter the [Automatic] option, you will see following message and printer will calibrate the sensor sensitivity automatically. When calibration process is completed, the LCD screen will return to the previous menu.

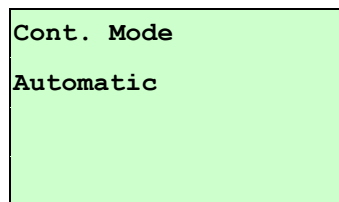

C-2 Manual

In case “Automatic” sensor calibration cannot apply to the media, please use “Manual” function to calibrate the sensor manually.

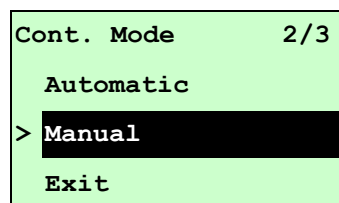

When enter [Manual] option, you will see following message. Please complete there steps :

| | |
|---|--|
| <pre> Cont. Mode Remove Label Intensity x Ref. Level xxx </pre> | <p>2. Remove the continuous label. Press the SELECT button to set the value into the printer.</p> |
| <pre> Cont. Mode Scan Paper Intensity x Ref. Level xxx </pre> | <p>2. Then, put the continuous label under the media sensor. Press the SELECT button to set the value into the printer.</p> |

| | |
|---|---|
| Cont. Mode Complete Intensity x Ref. Level xxx | 3. The sensor calibration is complete. Press the SELECT button the LCD screen will return to the previous menu. |
|---|---|

3.1.3 Serial Comm.

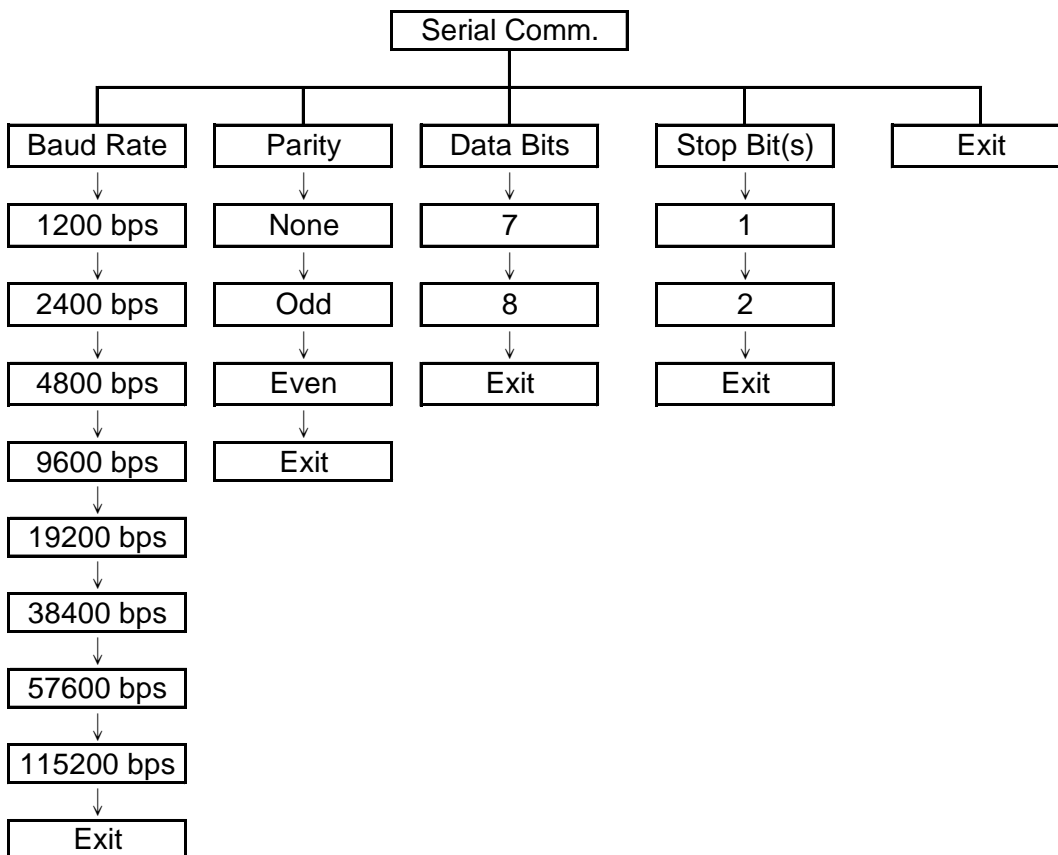

3.1.3.1 Baud Rate

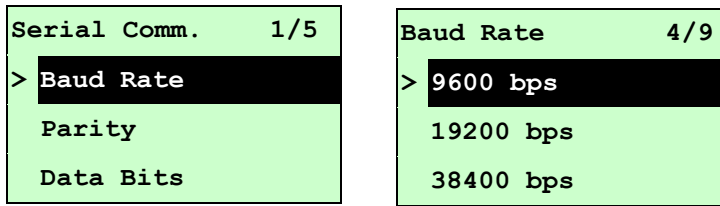

This option is used to set the RS-232 baud rate. The default setting is 9600 bps. Press **UP** ⤴ and **DOWN** ⤵ buttons to select the different baud rate and press **SELECT** button to set the value into printer. When you enter this list, the baud rate value in the right side of “>” icon is the current setting in the printer. Press **MENU** ⏮ key to cancel the setting and return to the previous menu.

3.1.3.2 Parity

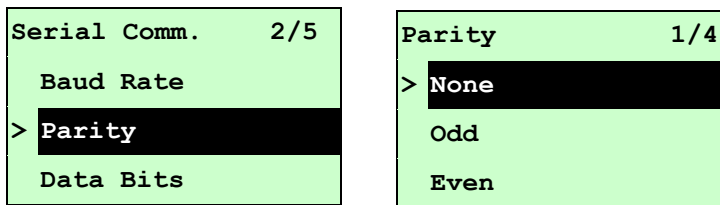

This option is used to set the RS-232 parity. The default setting is “None”. Press **UP** ⤴ and **DOWN** ⤵ buttons to select the different parity and press **SELECT** button to set the value into printer. When you enter this list, the parity in the right side of “>” is the printer current setting. Press **MENU** ⏮ key to cancel the setting and return to the previous menu.

3.1.3.3 Data Bits:

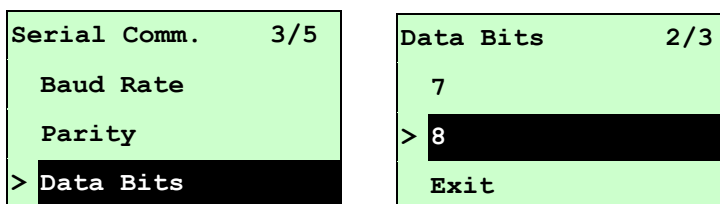



This option is used to set the RS-232 Data Bits. The default setting is “8” data bits. Press **UP** ⤴ and **DOWN** ⤵ buttons to select the different Data Bits and press **SELECT** button to set the value into printer. When you enter this list, the Data Bits in the right side of “>” icon is the printer current setting. Press **MENU** ⏮ key to cancel the setting and return to the previous menu.

3.1.3.4 Stop Bit(s):



```
Serial Comm.    4/5
  Parity
  Data Bits
> Stop Bit(s)
```

```
Stop Bit(s)    1/3
> 1
  2
  Exit
```

This option is used to set the RS-232 Stop Bits. The default setting is “1” stop bit. Press **UP**  and **DOWN**  buttons to select the different Stop Bits and press **SELECT** button to set the value into printer. When you enter this list, the option in the right side of “>” icon is the printer current setting. Press  **MENU** key to cancel the setting and return to the previous menu.

3.1.4 Ethernet

Use this menu to configure internal Ethernet configuration check the printer's Ethernet module status, and reset the Ethernet module. This function is available on the LCD display when Ethernet card is installed.

Press **UP**  and **DOWN**  buttons to select the different options and press **SELECT** button to enter the option. Press  **MENU** key to cancel the setting and return to the previous menu.

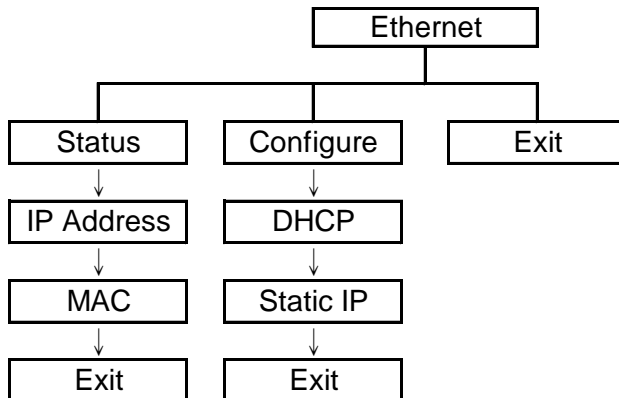

Note:

This function is available for TTP-2410M series only and option for TTP-246M Plus series.

3.1.4.1 Status: (IP Address / MAC)

Use this menu to check the Ethernet setting status.

3.1.4.1.1 IP Address

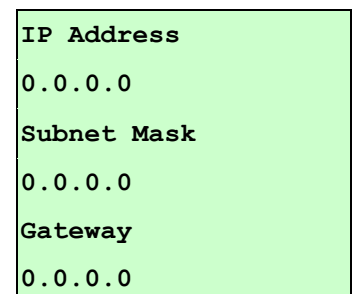
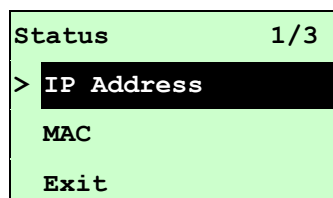
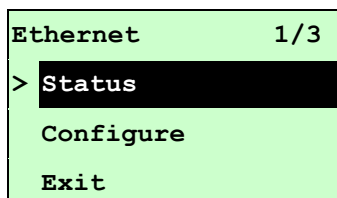

The IP address information will be shown on the LCD display. Please press **SELECT** or  **MENU** button to return to the previous menu.

3.1.4.1.2 MAC

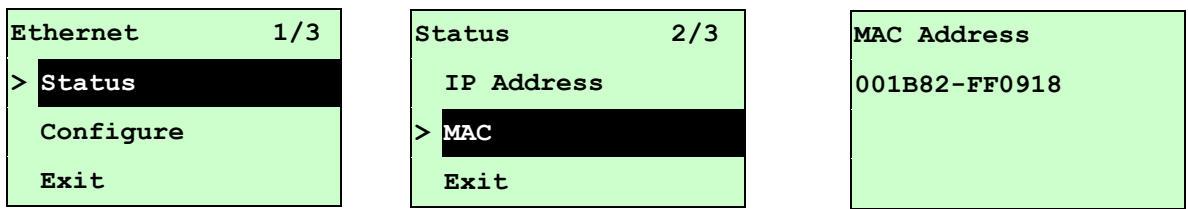

The MAC address information will be shown on the LCD display. Please press **SELECT** or **MENU** button to return to the previous menu.

3.1.4.2 Configure: (DHCP / Static IP)

Use this menu to set the printer's DHCP and Static IP.

3.1.4.2.1 DHCP

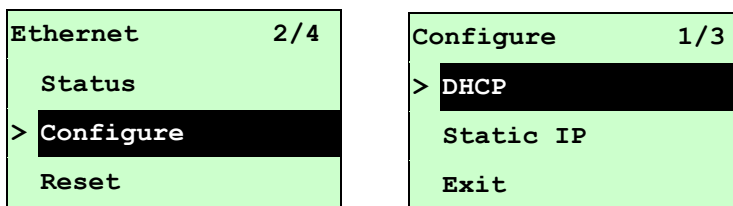

Press **UP** and **DOWN** buttons to select the DHCP function and press **SELECT** to enter. Press **MENU** key to cancel the setting and return to the previous menu.

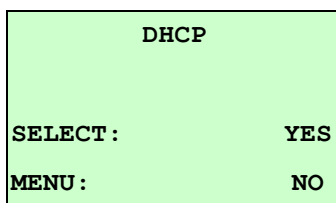

Press **SELECT** button the printer will set DHCP and restart to reset the setting. Press **MENU** button to return to the previous menu.

3.1.4.2.2 Static IP

Use this menu to set the printer's IP address, subnet mask and gateway.

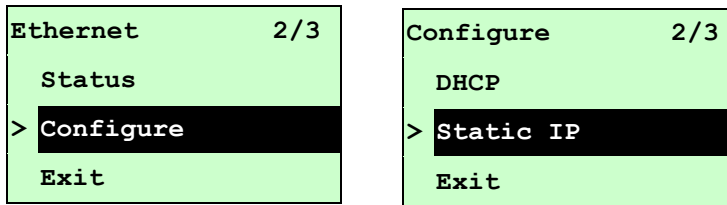

Press **UP** and **DOWN** buttons to select the different options and press **SELECT** button to enter the option. Press **MENU** key to cancel the setting and return to the previous menu.

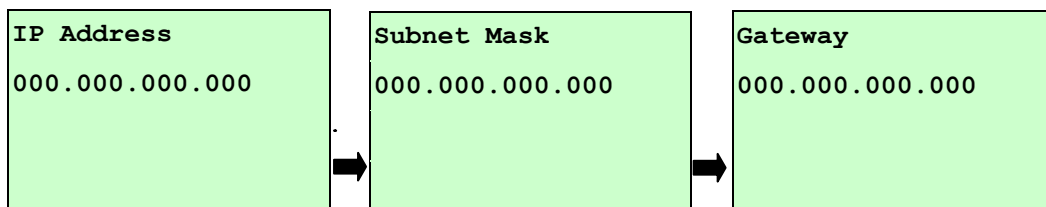

Press **DOWN** button to move the cursor from left to right digits and press the **UP** button to scroll the value from “0” to “9”. Press **SELECT** button to next setting.

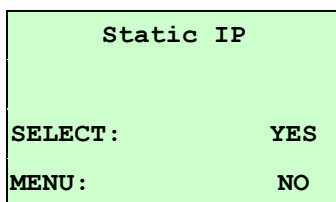

Press the **SELECT** button printer will restart to reset the Ethernet module setting. Press **MENU** key to cancel the setting.

3.2 File Manager

This feature is used to check the printer available memory and file list.

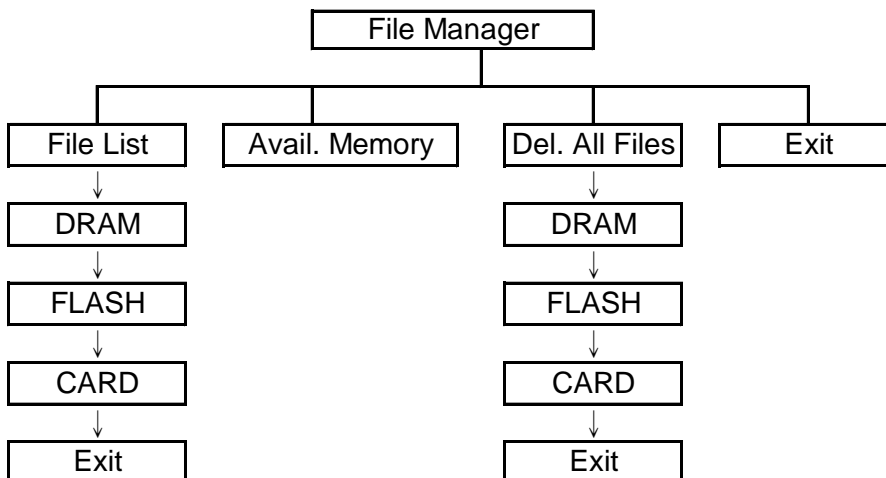

3.2.1 File List

Use this menu to show, delete and run (.BAS) the files saved in the printer DRAM/Flash/Card memory.

To show the files :

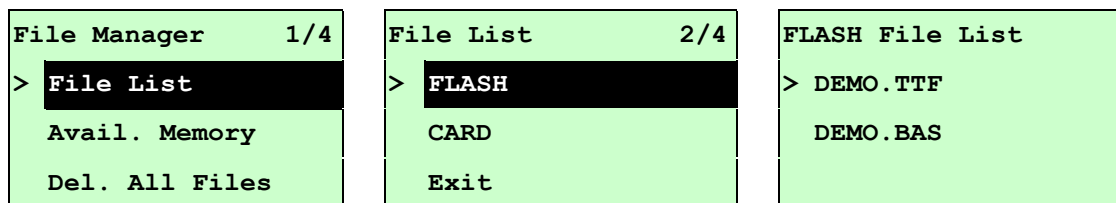

To delete the file : Please follow the order to press the **DOWN** ⓪ button.

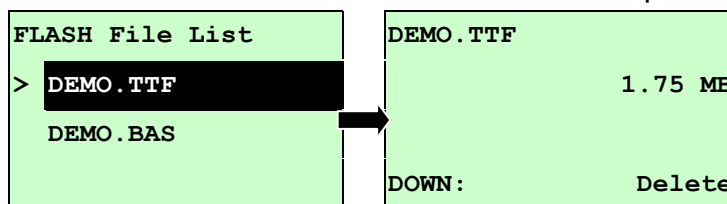

To run the file (.BAS) : Please follow the order to press the **SELECT** button.

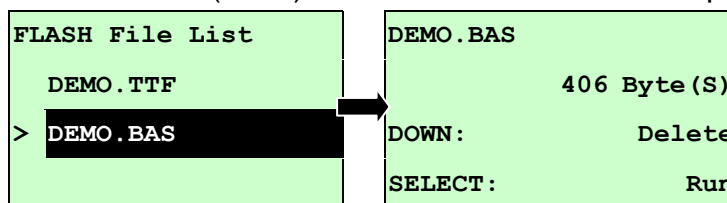

3.2.2 Avail. Memory

Use this menu to show available memory space.

```

File Manager      2/4
  File List
> Avail. Memory
  Del. All Files
  
```

```

Avail. Memory
DRAM:             256 KB
FALSH:           6656 KB
CARD:             0 KB
  
```

3.2.3 Del. All Files

Use this menu to delete all files. Press **SELECT** button to delete all files in the device.

Press **MENU** to cancel deleting files and go back to previous menu.

```

File Manager      3/4
  File List
  Avail. Memory
> Del. All File
  
```

```

File List        1/4
> DRAM
  FALSH
  CARD
  
```

```

Del. All Files

SELECT:          YES
MENU:            NO
  
```

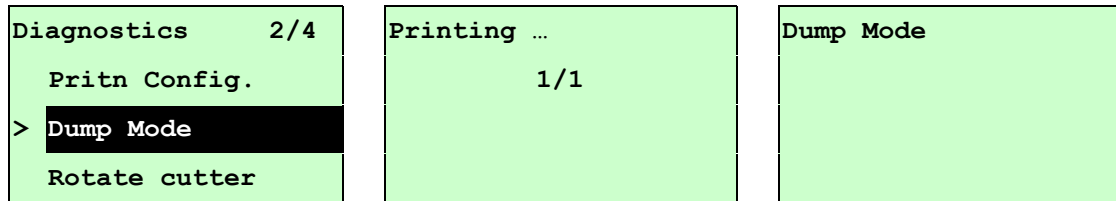

3.3.2 Dump Mode

Captures the data from the communications port and prints out the data received by printer. In the dump mode, all characters will be printed in 2 columns as following. The left side characters are received from your system and right side data are the corresponding hexadecimal value of the characters. It allows users or engineers to verify and debug the program.

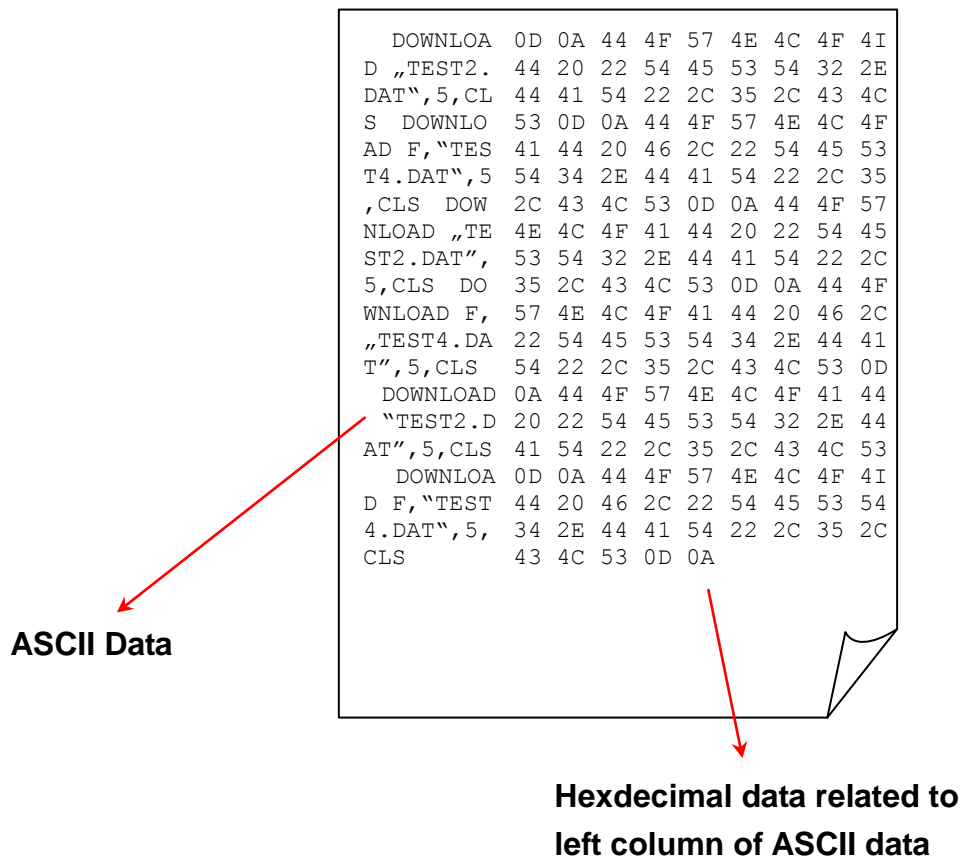

Note:

- 1. Dump mode requires 4" wide paper width.**
- 2. Turn off / on the power to resume printer for normal printing.**
- 3. Press FEED button to back to the previous menu.**



3.3.3 Rotate Cutter

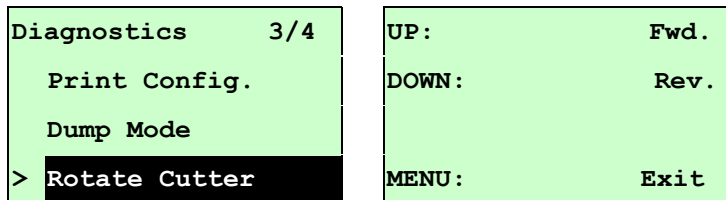

In case paper is jammed in the cutter, this feature can rotate the cutter blade forward or reverse direction, which is helpful to remove the jammed paper easily from the cutter.

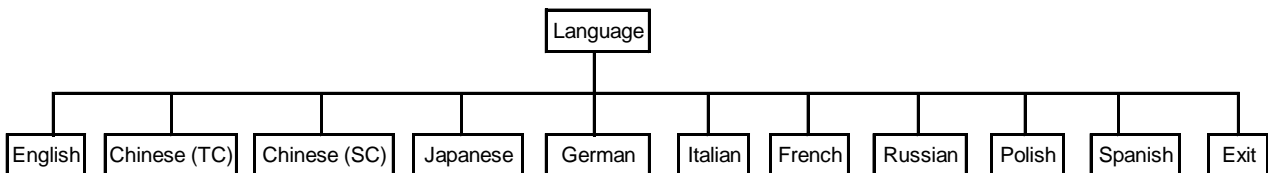

3.4 Language



This option is used to setup the language on LCD display.

Press **UP**  and **DOWN**  buttons to scroll the cursor to desire language and press **SELECT** button to select this option. Press  **MENU** key to cancel the setting and return to the previous menu. The default language setting is English.

3.5 Service

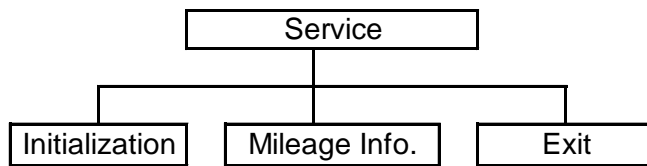

This feature is used to restore printer settings to defaults and display printer mileage information.

3.5.1 Initialization

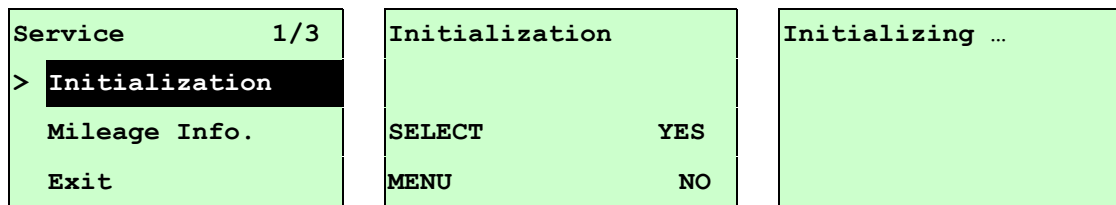

The printer settings are restored to defaults as below once printer is initialized.

Note :

When printer initialization is done, please calibrate the gap or black mark sensor before printing.

| Parameter | Default setting |
|-----------------------------|---|
| Speed | TTP-2410M : 6 IPS (152 mm/sec) TTP-346M/246M Plus/344M Pius : 4 IPS (101.6 mm/sec) TTP-644M : 3 IPS (76.2 mm/sec) |
| Density | 8 |
| Label width | 4.00"(101.6mm) |
| Label height | 4.00"(101.6mm) |
| Sensor type | Gap sensor |
| Gap setting | 0.12"(3.0mm) |
| Print direction | 0 |
| Reference point | 0,0(upper left corner) |
| Offset | 0 |
| Print mode | Batch mode |
| Serial port settings | 9600 bps, none parity, 8 data bits, 1 stop bit |
| Code page | 850 |
| Country code | 001 |
| Clear flash memory | No |
| Shift X | 0 |

| | |
|---------------------------------|---|
| Shift Y | 0 |
| Gap sensor sensitivity | 3 (Will be reset. Need to re-calibrate the gap) |
| Bline sensor sensitivity | 2 (Will be reset. Need to re-calibrate the gap) |
| Language | English |
| IP address | DHCP |

3.5.2 Mileage Info.

Use this option to check the printed mileage (displayed in meter).

| | |
|-----------------|----------------|
| Service 1/3 | Mileage: (m) |
| Initialization | 4016 |
| > Mileage Info. | Labels: (pcs.) |
| Exit | 51698 |

4. Diagnostic Tool

The Diagnostic Utility is a toolbox that allows users to explore the printer's settings and status; change printer settings; download graphics, fonts, and firmware; create printer bitmap fonts; and to send additional commands to the printer. Using this convenient tool, you can explore the printer status and settings and troubleshoot the printer.

Note: This utility works with printer firmware V6.00 and later versions.

4.1 Start the Diagnostic Tool

1. Double click on the Diagnostic tool icon  `DiagTool.exe` to start the software.
2. There are four features (Printer Configuration, File Manager, Bitmap Font Manager, Command Tool) included in the Diagnostic utility.

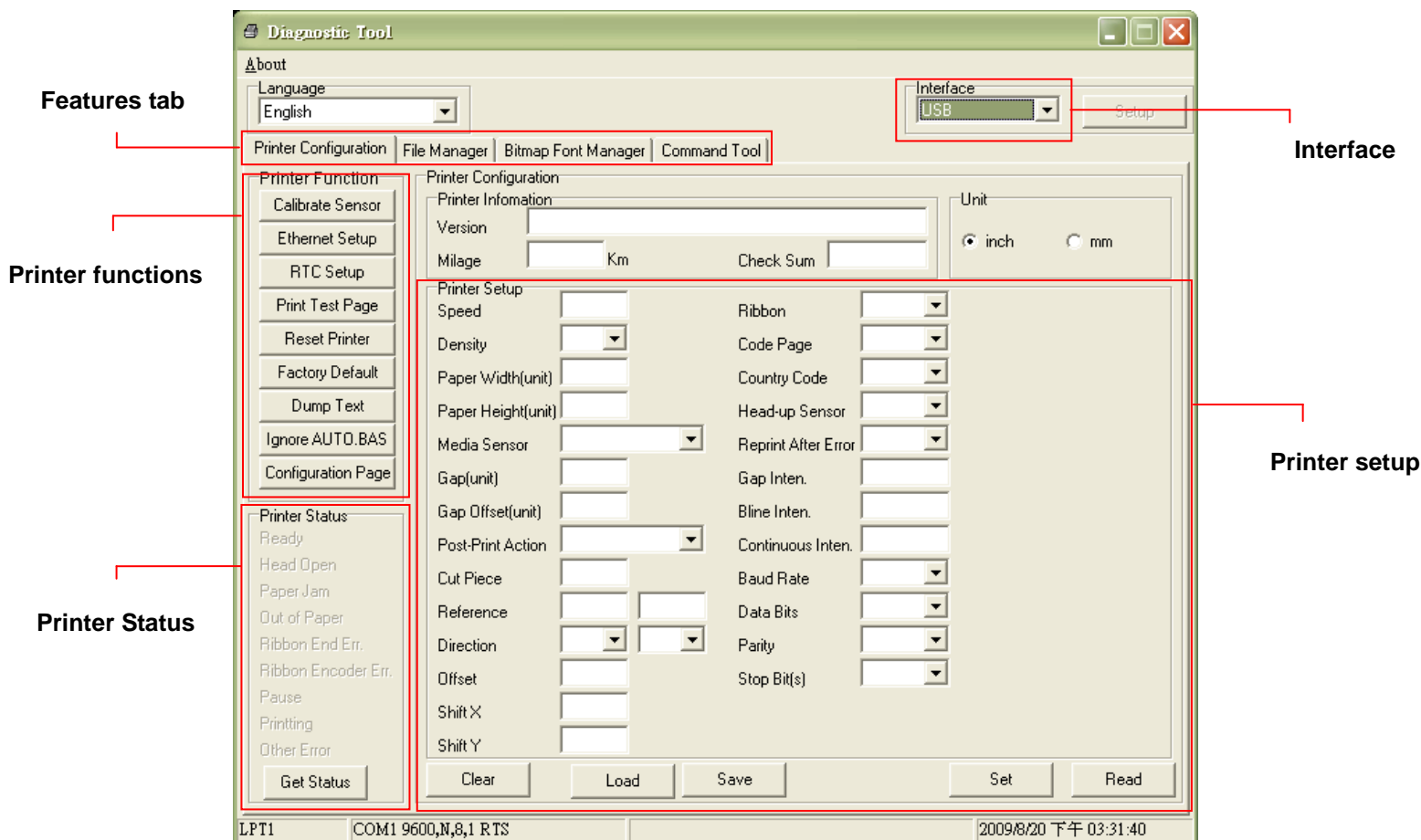

4.2 Printer Function (Calibrate sensor, Ethernet setup, RTC setup.....)

1. Select the PC interface connected with bar code printer.
2. Click the “Function” button to setting.
3. The detail functions in the Printer Function Group are listed as below.

| | Function | Description |
|--------------------|--------------------|---|
| Printer Function | Calibrate Sensor | Calibrate the sensor specified in the Printer Setup group media sensor field |
| Calibrate Sensor | Ethernet Setup | Setup the IP address, subnet mask, gateway for the on board Ethernet (Please refer to next section) |
| Ethernet Setup | RTC Setup | RTC Time |
| RTC Setup | Print Test Page | Synchronize printer Real Time Clock with PC |
| Print Test Page | Reset Printer | Print a test page |
| Reset Printer | Factory Default | Reboot printer |
| Factory Default | Dump Text | Initialize the printer and restore the settings to factory default. |
| Dump Text | Ignore AUTO.BAS | To activate the printer dump mode. |
| Ignore AUTO.BAS | Configuration Page | Ignore the downloaded AUTO.BAS program |
| Configuration Page | | Print printer configuration |

Note:

For more information about Diagnostic Tool, please refer to the diagnostic utility quick start guide in the CD disk \ Utilities directory.

5 Setting Ethernet by Diagnostic Utility (Optional for TTP-246M Plus/TTP-344M Plus models)

The Diagnostic Utility is enclosed in the CD disk \Utilities directory. Users can use Diagnostic Tool to setup the Ethernet by RS-232, USB and Ethernet interfaces. The following contents will instruct users how to configure the Ethernet by these three interfaces.

5.1 Using USB interface to setup Ethernet interface

1. Connect the USB cable between the computer and the printer.
2. Turn on the printer power.
3. Start the Diagnostic Utility by double clicking on the  `DiagTool.exe` icon.

Note: This utility works with printer firmware V6.00 and later versions.

4. The Diagnostic Utility default interface setting is USB interface. If USB interface is connected with printer, no other settings need to be changed in the interface field.

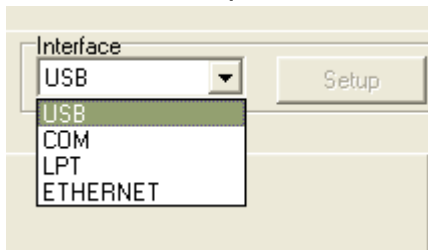

5. Click on the “Ethernet Setup” button from “Printer Function” group in Printer Configuration tab to setup the IP address, subnet mask and gateway for the on board Ethernet.

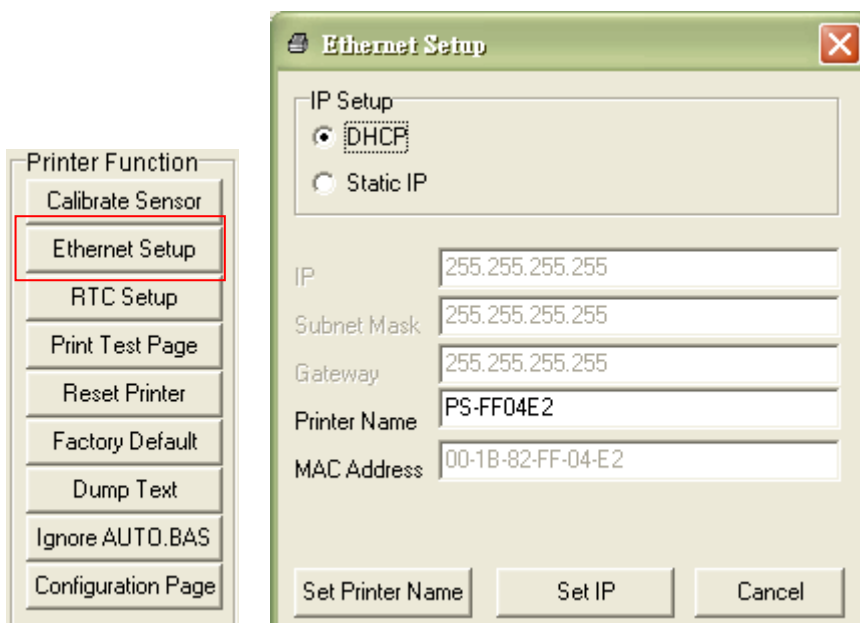

5.2 Using RS-232 interface to setup Ethernet interface

1. Connect the computer and the printer with a RS-232 cable.
2. Turn on the printer power.
3. Start the Diagnostic Utility by double clicks on the  `DiagTool.exe` icon.
Note: This utility works with printer firmware V6.00 and later versions.
4. Select “COM” as interface then click on the “Setup” button to setup the serial port baud rate, parity check, data bits, stop bit and flow control parameters.



5. Click on the “Ethernet Setup” button from printer function of Printer Configuration tab to setup the IP address, subnet mask and the gateway for the on board Ethernet.

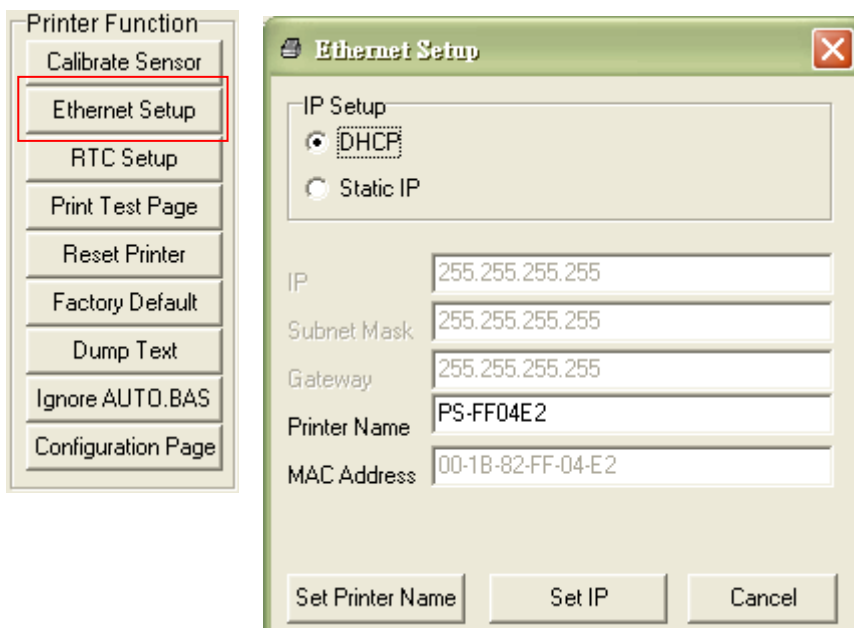

5.3 Using Ethernet interface to setup Ethernet interface

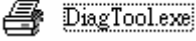
1. Connect the computer and the printer to the LAN.
2. Turn on the printer power.
3. Start the Diagnostic Utility by double clicks on the  icon.
Note: This utility works with printer firmware V6.00 and later versions.
4. Select “Ethernet” as the interface then click on the “Setup” button to setup the IP address, subnet mask and gateway for the on board Ethernet.

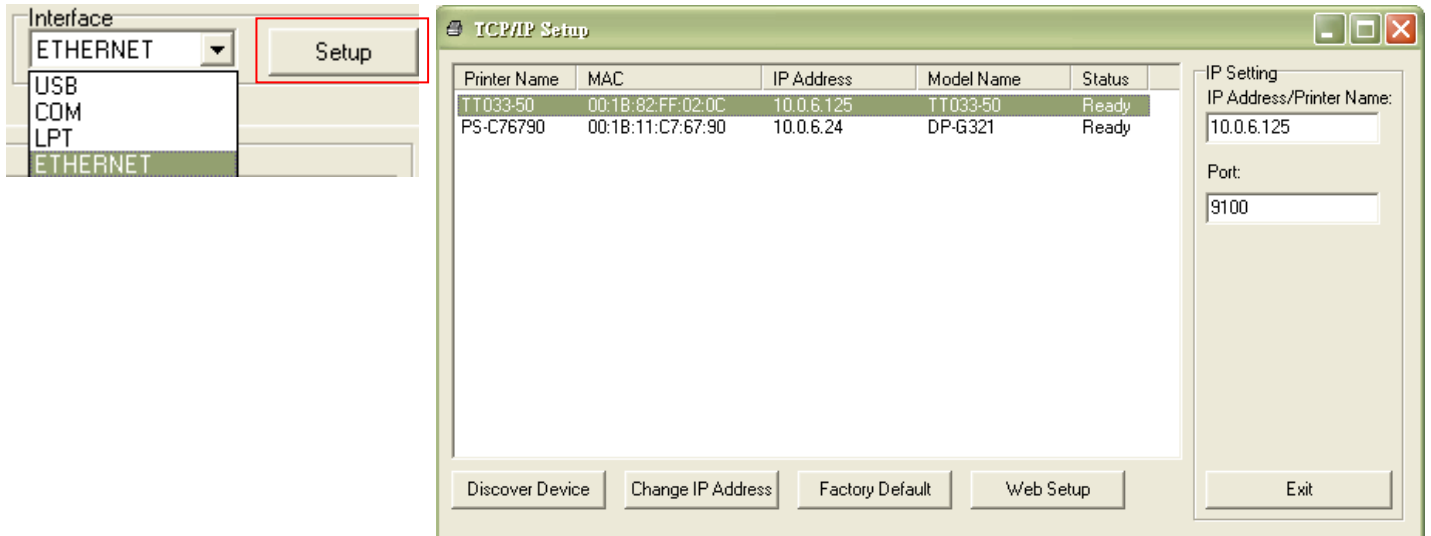

5. Click the “Discover Device” button to explore the printers that exist on the network.
6. Select the printer in the left side of listed printers, the correspondent IP address will be shown in the right side “IP address/Printer Name” field.
7. Click “Change IP Address” to configure the IP address obtained by DHCP or static.

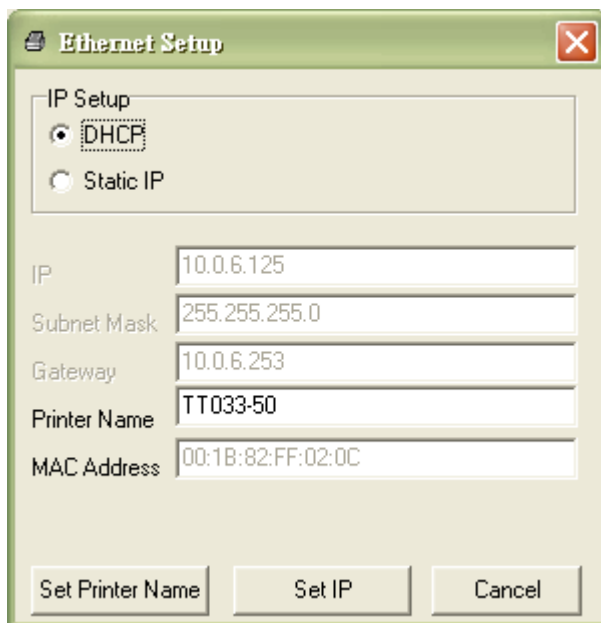

The default IP address is obtained by DHCP. To change the setting to static IP

address, click “Static IP” radio button then enter the IP address, subnet mask and gateway. Click “Set IP” to take effect the settings.

Users can also change the “Printer Name” by another model name in this fields then click “Set Printer Name” to take effect this change.

Note: After clicking the “Set Printer Name” or “Set IP” button, printer will reset to take effect the settings.

8. Click “Exit” button to exit the Ethernet interface setup and go back to Diagnostic Tool main screen.

Factory Default button

This function will reset the IP, subnet mask, gateway parameters obtained by DHCP and reset the printer name.

Web setup button

Except to use the Diagnostic Utility to setup the printer, you can also explore and configure the printer settings and status or update the firmware with the IE or Firefox web browser. This feature provides a user friendly setup interface and the capability to manage the printer remotely over a network.

6. Troubleshooting

6.1 Common Problems

The following guide lists the most common problems that may be encountered when operating this bar code printer. If the printer still does not function after all suggested solutions have been invoked, please contact the Customer Service Department of your purchased reseller or distributor for assistance.

| Problem | Possible Cause | Recovery Procedure |
|---|--|--|
| Power indicator does not illuminate | * The power cord is not properly connected. | * Plug the power cord in printer and outlet. * Switch the printer on. |
| Carriage Open | * The printer carriage is open. | * Please close the print carriage. |
| No Ribbon | * Running out of ribbon. * The ribbon is installed incorrectly. | * Supply a new ribbon roll. * Please refer to the steps in user's manual to reinstall the ribbon. |
| No Paper | * Running out of label. * The label is installed incorrectly. * Gap/black mark sensor is not calibrated. | * Supply a new label roll. * Please refer to the steps in user's manual to reinstall the label roll. * Calibrate the gap/black mark sensor. |
| Paper Jam | * Gap/black mark sensor is not set properly. * Make sure label size is set properly. * Labels may be stuck inside the printer mechanism. | * Calibrate the gap/black mark sensor. * Set label size correctly. |
| Take Label | * Peel function is enabled. | * If the peeler module is installed, please remove the label. * If there is no peeler module in front of the printer, please switch off the printer and install it. * Check if the connector is plugging correctly. |
| UP: Fwd. DOWN: Rev. MENU: Exit | * Cutter jam. * There is no cutter installed on the printer. * Cutter PCB is damaged. | * If the cutter module is installed, please press UP or DOWN key to rotate the cutter up or down to make the knife back to the right position. * Remove the label. * Make sure the thickness of label is less than 200 g/m ² (for regular cutter) or 300 g/m ² (for heavy duty cutter). * Replace a cutter PCB. |

| | | |
|--|---|---|
| <p>Not Printing</p> | <p>* Cable is not well connected to serial or USB interface or parallel port. * The serial port cable pin configuration is not pin to pin connected.</p> | <p>* Re-connect cable to interface. * If using serial cable, - Please replace the cable with pin to pin connected. - Check the baud rate setting. The default baud rate setting of printer is 9600,n,8,1. * If using the Ethernet cable, - Check if the Ethernet RJ-45 connector green LED is lit on.. - Check if the Ethernet RJ-45 connector amber LED is blinking. - Check if the printer gets the IP address when using DHCP mode. - Check if the IP address is correct when using the static IP address. - Wait a few seconds let the printer get the communication with the server then check the IP address setting again. * Change a new cable. * Ribbon and media are not compatible. * Verify the ribbon-inked side. * Reload the ribbon again. * Clean the printhead. * The print density setting is incorrect. * Printhead's harness connector is not well connected with printhead. Turn off the printer and plug the connector again. * Check if the stepping motor is plugging in the right connector. * Check your program if there is a command PRINT at the end of the file and there must have CRLF at the end of each command line.</p> |
| <p>Memory full (FLASH / DRAM)</p> | <p>* The space of FLASH/DRAM is full.</p> | <p>* Delete unused files in the FLASH/DRAM. * The max. numbers of file of DRAM is 256 files. * The max. user addressable memory space of DRAM is 256 KB for TTP-246M Plus/TTP-344M Plus and 2048KB for TTP-2410M/TTP-346M. * The max. numbers of file of FLASH is 256 files. * The max. user addressable memory space of FLASH is 2560 KB for TTP-246M Plus/TTP-344M Plus and 6656KB for TTP-2410M/TTP-346M.</p> |
| <p>SD card is unable to use</p> | <p>* SD card is damaged. * SD card doesn't insert correctly. * Use the non-approved SD card manufacturer.</p> | <p>* Use the supported capacity SD card. * Insert the SD card again. * The supported SD card spec and the approved SD card manufacturers, please refer to section 2.2.3.</p> |
| <p>PS/2 port does not work</p> | <p>* Did not turn off power prior to plug in the PS/2 keyboard. * PS/2 keyboard is damaged. * PS/2 keyboard doesn't plug-in correctly. * There is no BAS file in the printer.</p> | <p>* Turn off printer power prior to plug in the PS/2 keyboard. * Plug the PS/2 keyboard again. * Make sure the keyboard is fine. * Make sure if there is any BAS file downloaded into printer.</p> |

| | | |
|---|--|---|
| <p>Poor Print Quality</p> | <ul style="list-style-type: none"> * Ribbon and media is loaded incorrectly * Dust or adhesive accumulation on the print head. * Print density is not set properly. * Printhead element is damaged. * Ribbon and media are incompatible. * The printhead pressure is not set properly. | <ul style="list-style-type: none"> * Reload the supply. * Clean the printhead. * Clean the platen roller. * Adjust the print density and print speed. * Run printer self-test and check the print head test pattern if there is dot missing in the pattern. * Change proper ribbon or proper label media. * Adjust the printhead pressure adjustment knob. <ul style="list-style-type: none"> - If the left side printout is too light, please adjust the left side pressure adjustment knob to the higher index (higher pressure). If the pressure adjustment knob has been adjust to index “5” and the poor print quality is still at the left side of the printout, please adjust the pressure adjustment knob to index “1” and use the Z-axis adjustment knob to fine tune the pressure. - If the right side printout is too light, please adjust the right side pressure adjustment knob to the higher index (higher pressure) to improve the print quality. * If the label thickness is more than 0.22 mm, the print quality might be not good enough, please adjust the heater line adjustment screw counter clockwise to get the best print quality. * The release lever does not latch the printhead properly. |
| <p>LCD panel is dark but the LEDs are light</p> | <ul style="list-style-type: none"> * The printer initialization is unsuccessful. | <ul style="list-style-type: none"> * Turn OFF and ON the printer again. * Initialize the printer. |
| <p>LCD panel is dark and LEDs are lit on, but the label is feeding forward</p> | <ul style="list-style-type: none"> * The LCD panel harness connector is loose. | <ul style="list-style-type: none"> * The LCD panel harness connector is plugged upside down. |
| <p>Ribbon end sensor doesn't work</p> | <ul style="list-style-type: none"> * The ribbon sensor hole is covered with dust. | <ul style="list-style-type: none"> * Clear the dust in the sensor hole by the blower. |
| <p>Peel sensor is not working</p> | <ul style="list-style-type: none"> * Peel sensor is not located on the correct position. * The connector is loose. | <ul style="list-style-type: none"> * Make sure that the media goes through the Peel sensor. * Plug the connect cable correctly. |
| <p>Cutter is not working</p> | <ul style="list-style-type: none"> * The connector is loose. | <ul style="list-style-type: none"> * Plug in the connect cable correctly. |
| <p>Label feeding is not stable (skew) when printing</p> | <ul style="list-style-type: none"> * The media guide does not touch the edge of the media. | <ul style="list-style-type: none"> * If the label is moving to the right side, please move the label guide to left. * If the label is moving to the left side, please move the label guide to right. |
| <p>Skip labels when printing</p> | <ul style="list-style-type: none"> * Label size is not specified properly. * Sensor sensitivity is not set properly. * The media sensor is covered with dust. | <ul style="list-style-type: none"> * Check if label size is setup correctly. * Calibrate the sensor by Auto Gap or Manual Gap options. * Clear the GAP/Black mark sensor by blower. |

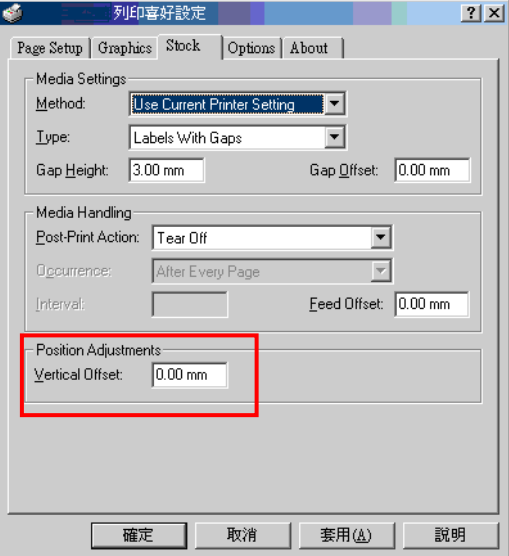
| | | |
|---|---|---|
| <p>The printing position of small label is incorrect</p> | <ul style="list-style-type: none"> * Media sensor sensitivity is not set properly. * Label size is incorrect. * The parameter Shift Y in the LCD menu is incorrect. * The vertical offset setting in the driver is incorrect. | <ul style="list-style-type: none"> * Calibrate the sensor sensitivity again. * Set the correct label size and gap size. * Press [MENU] → [SELECT] x3 → [DOWN]x6 → [SELECT] to fine tune the parameter of Shift Y. * If using the software BarTender, please set the vertical offset in the driver.  |
| <p>The left side printout position is incorrect</p> | <ul style="list-style-type: none"> * Wrong label size setup. * The parameter Shift X in LCD menu is incorrect. | <ul style="list-style-type: none"> * Set the correct label size. * Press [MENU] → [SELECT] x 3 → [DOWN] x 5 → [SELECT] to fine tune the parameter of Shift X. |
| <p>Missing printing on the left or right side of label</p> | <ul style="list-style-type: none"> * Wrong label size setup. | <ul style="list-style-type: none"> * Set the correct label size. |
| <p>RTC time is incorrect when reboot the printer</p> | <ul style="list-style-type: none"> * The battery has run down. | <ul style="list-style-type: none"> * Check if there is a battery on the main board. |
| <p>Multi interface board doesn't work</p> | <ul style="list-style-type: none"> * The installation is incorrect. | <ul style="list-style-type: none"> * Check if the board is plugged in the right connector. |
| <p>Power and Error LEDs are blinking fast</p> | <ul style="list-style-type: none"> * Power switch OFF and ON too fast. | <ul style="list-style-type: none"> * Turn off the printer and wait all LEDs are dark, and turn on the printer again. |
| <p>Wrinkle Problem</p> | <ul style="list-style-type: none"> * Printhead pressure is incorrect. * Ribbon installation is incorrect. * Media installation is incorrect. * Print density is incorrect. * Media feeding is incorrect. | <ul style="list-style-type: none"> * Please refer to the next chapter. * Please set the suitable density to have good print quality. * Make sure the label guide touch the edge of the media guide. |
| <p>Gray line on the blank label</p> | <ul style="list-style-type: none"> * The printhead is dirty. * The platen roller is dirty. | <ul style="list-style-type: none"> * Clean the printhead. * Clean the platen roller. |
| <p>Irregular printing</p> | <ul style="list-style-type: none"> * The printer is in Hex Dump mode. * The RS-232 setting is incorrect. | <ul style="list-style-type: none"> * Turn off and on the printer to skip the dump mode. * Re-set the Rs-232 setting. |

6.2 Mechanism Fine Adjustment to Avoid Ribbon Wrinkles

This printer has been fully tested before delivery. There should be no ribbon wrinkle presented on the media for general-purpose printing application. Ribbon wrinkle is related to the media thickness, print head pressure balance, ribbon film characteristics, print darkness setting...etc. In case the ribbon wrinkle happens, please follow the instructions below to adjust the printer parts.

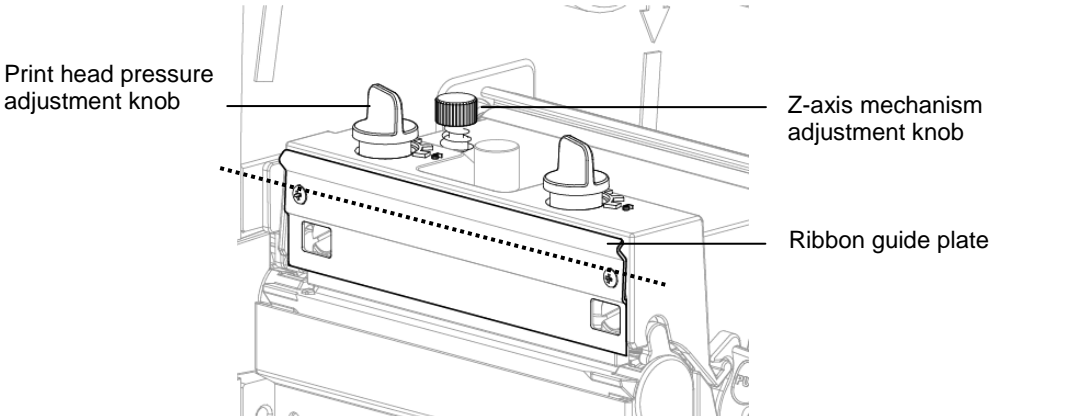
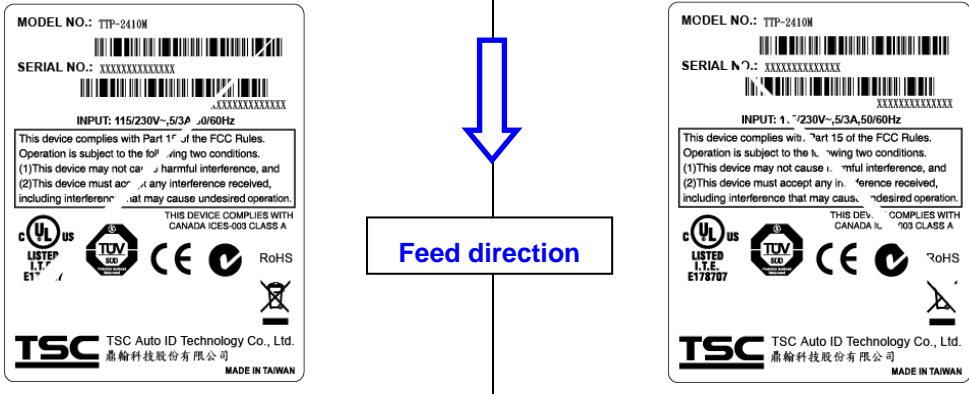
| | | |
|--|--|--|
| <p>Adjustable Printer Parts</p> |  | |
| <p>Symptom</p> | <p>1. Wrinkle happens from label lower left to upper right direction (“ ’ ”)</p> | <p>2. Wrinkle happens from label lower right to upper left direction (“ ` ”)</p> |
| <p>Wrinkle Example</p> |  | |

Adjust the print head pressure adjustment knob

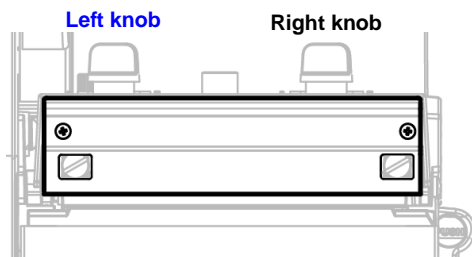

The print head pressure adjustment knob has 5 levels of settings. Clockwise direction adjustment is to increase the print head pressure. Counter Clockwise adjustment can decrease the print head pressure.

If the wrinkle on the label starts from the lower left side to upper right side, please do following adjustment.

1. Decrease the right side print head pressure adjustment knob setting 1 level per each adjustment then print the label again to check if wrinkle is gone.
2. If the right side print head adjustment knob setting has been set to index 1 (the lowest pressure index), please increase the left side print head pressure.
3. If the left side print head adjustment knob setting has been set to 5 (the highest pressure index) the wrinkle can't be avoid, please rotate the both knobs back to setting 1 then rotate the Z-axis mechanism adjustment knob clockwise for a few degrees and print again for fine tune the print head pressure distribution.

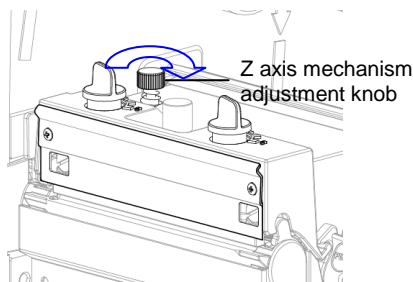

Note for step 3:

- *Factory default setting, the Z-axis knob is rotated counter clockwise to the end of thread.
- *Turn the Z-axis mechanism adjustment knob clockwise until you feel the knob touch the mechanism for the first adjustment.
- * If the wrinkle is still there, please turn the Z-axis mechanism adjustment knob clockwise about 1/4 circle each time for adjustment
- * If the wrinkled direction is change from “ ´ ” to “ ` ” by adjusting the Z-axis mechanism adjustment knob, please turn the Z axis mechanism adjustment knob counter clockwise to avoid the wrinkle.

Adjust the print head pressure adjustment knob

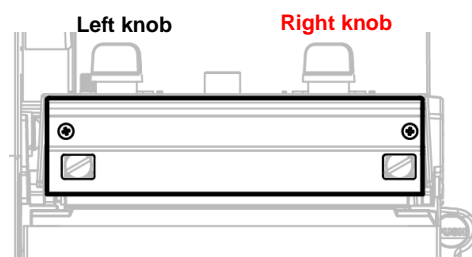

The print head pressure adjustment knob has 5 levels of settings. Clockwise direction adjustment is to increase the print head pressure. Counter Clockwise adjustment can decrease the print head pressure.

If the wrinkle on the label starts from the lower right side to upper left side, please do following adjustment.

1. Decrease the left side print head pressure adjustment knob setting 1 level per each adjustment then print the label again to check if wrinkle is gone.
2. If the left side print head adjustment knob level has been set to index 1 (the lowest index), please increase the right side print head pressure.

7. Maintenance

This session presents the clean tools and methods to maintain your printer.

2. Please use one of following material to clean the printer.

- Cotton swab (Head cleaner pen)
- Lint-free cloth
- Vacuum / Blower brush
- 100% ethanol

2. The cleaning process is described as following

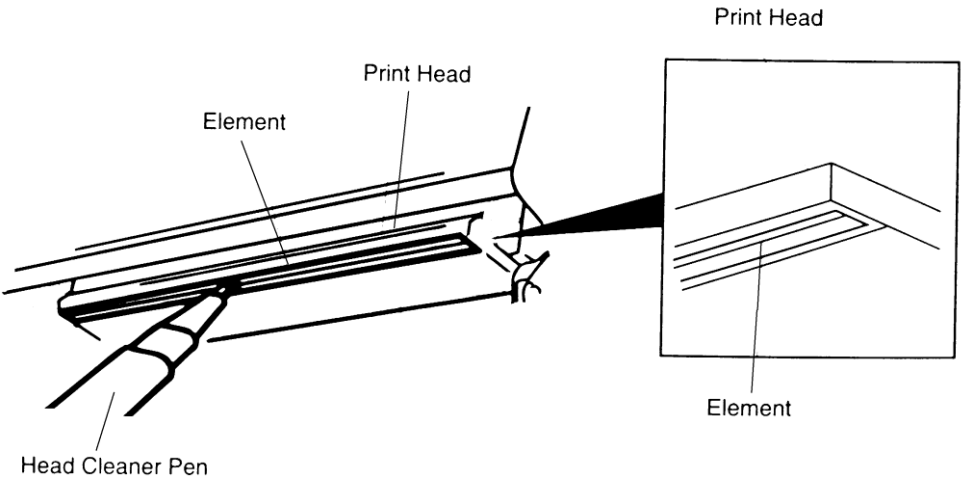
| Printer Part | Method | Interval |
|---------------------------------|--|---|
| <p>Print Head</p> | <p>1. Always turn off the printer before cleaning the print head. 2. Allow the print head to cool for a minimum of one minute. 3. Use a cotton swab (Head cleaner pen) and 100% ethanol to clean the print head surface.</p> | <p>Clean the print head when changing a new label roll</p> |
| |  <p>The diagram illustrates the cleaning process of the print head. It shows a side view of the print head assembly with a 'Head Cleaner Pen' being used to clean the 'Print Head' surface. An 'Element' is also labeled. An inset shows a close-up of the 'Print Head' and 'Element'.</p> | |
| <p>Platen Roller</p> | <p>1. Turn the power off. 2. Rotate the platen roller and wipe it thoroughly with 100% ethanol and a cotton swab, or lint-free cloth.</p> | <p>Clean the platen roller when changing a new label roll</p> |
| <p>Tear Bar/Peel Bar</p> | <p>Use the lint-free cloth with 100% ethanol to wipe it.</p> | <p>As needed</p> |
| <p>Sensor</p> | <p>Compressed air or vacuum</p> | <p>Monthly</p> |
| <p>Exterior</p> | <p>Wipe it with water-dampened cloth</p> | <p>As needed</p> |
| <p>Interior</p> | <p>Brush or vacuum</p> | <p>As needed</p> |

Note:

- Do not touch printer head by hand. If you touch it careless, please use ethanol to clean it.
- Please use 100% Ethenol. DO NOT use medical alcohol, which may damage the printer head.
- Regularly clean the print head and supply sensors once change a new ribbon to keep printer performance and extend printer life.

Revise History

| Date | Content | Editor |
|-------------------|---|---------------|
| 2007/10/24 | Update Ethernet section. (Section 3.1.4) | Camille |
| 2007/10/31 | Add SD card specification. (Section 2.2.3) | Camille |
| 2007/11/7 | Modify section 2.2.3 (SD card) | Camille |
| 2007/11/15 | Modify chapter 2.2 (Printer overview) | Camille |
| 2007/11/21 | Add section 2.6.3 & 2.6.4 (Loading media in peel-off mode /Option) | Camille |
| 2008/2/21 | Add section 2.6.5 & 2.6.6 (Loading media in rewind liner with label mode/Option & Remove labels from internal rewind) | Camille |
| 2008/3/7 | Revise maintenance section | Camille |
| 2008/4/16 | 1. Revise menu function section 2. Revise troubleshooting section 3. Add diagnostic tool section | Camille |
| 2008/9/16 | Revise the print head burn line adjustment knob section | Camille |
| 2008/10/7 | Revise troubleshooting section (memory full) | Camille |
| 2009/3/11 | Revise 2.2.3 & 5.1 sections (Recommended SD card specification) | Camille |
| 2009/5/15 | 1. Add 3.1.1-2 Printer Setup(ZPL2) section 2. Add 2.8 section (Using the keyboard with PS/2 interface) | Camille |
| 2009/6/16 | Add caution to 1.2 section | Camille |
| 2009/10/13 | 1. Revise 4 section 2. Add 5 section (Setting Ethernet by Diagnostic Utility) | Camille |
| 2010/8/13 | Revise section 1.2 | Camille |
| 2011/1/25 | Modify TSC address | Camille |
| 2011/7/29 | Modify section 2.6.1 | Camille |
| 2011/9/15 | Modify section 1.2 & 6.1 | Camille |
| 2011/12/2 | Modify section 2.3.2 | Camille |
| 2012/5/18 | Add a note for section 2.5.1 (loading the ribbon) | Camille |



TSC Auto ID Technology Co., Ltd.

Corporate Headquarters

9F., No.95, Minquan Rd., Xindian Dist.,
New Taipei City 23141, Taiwan (R.O.C.)

TEL: +886-2-2218-6789

FAX: +886-2-2218-5678

Web site: www.tscprinters.com

E-mail: printer_sales@tscprinters.com

tech_support@tscprinters.com

Li Ze Plant

No.35, Sec. 2, Ligong 1st Rd., Wujie Township,
Yilan County 26841, Taiwan (R.O.C.)

TEL: +886-3-990-6677

FAX: +886-3-990-5577